

# KitchenAid®

## Food Processor

Instructions

11 Cup Models



1-800-541-6390  
Details Inside



## Total Replacement Warranty

---

We're so confident the quality of our products meets the exacting standards of KitchenAid that, if your food processor should fail within the first year of ownership, KitchenAid will arrange to deliver an identical or comparable replacement to your door free of charge and arrange to have your "failed" food processor returned to us. Your replacement unit is covered by our one year full warranty. Please follow these instructions to receive this quality service.



**If you reside in the United States** and your KitchenAid® food processor should fail within the first year of ownership, simply call our toll-free Customer Satisfaction Center at **1-800-541-6390**, 8 a.m. to 8 p.m., Monday through Friday, 9 a.m. to 3 p.m., Saturday, Eastern time.

Give the consultant your complete shipping address. (No P.O. Box Numbers, please.)

Give the consultant your complete model and serial number.

KitchenAid will arrange to deliver a replacement food processor and have your "failed" food processor returned to us.

Put your "failed" food processor in the original shipping carton along with a sheet of paper with your name and address on it, and proof of purchase (register receipt, credit card charge slip, etc.)

The consultant will also identify the Authorized Service Center nearest your location.



# Table of Contents

---

Total Replacement Warranty.....	2
Important Safeguards.....	4
Warranty.....	6
How To Arrange For Service - USA Only.....	7
Standard First Year Warranty.....	7
How To Arrange For Service - Outside The USA.....	7
If You Need Service or Assistance.....	8
Electrical Requirements.....	8
Product Registration Card.....	9
How To Obtain Service.....	9
Food Processor Features.....	10
Assembling Your Food Processor.....	12
Egg Whip.....	15
Operating Your Food Processor.....	16
Disassembling Your Food Processor.....	17
Care and Cleaning.....	18
Food Processor Tips.....	19
Helpful Hints.....	22
Recipes.....	24
Appetizers.....	24
Salads and Dressings.....	34
Soups and Sandwiches.....	42
Vegetables and Side Dishes.....	51
Main Dishes.....	58
Breads.....	74
Desserts.....	83
Optional Attachments and Accessories.....	93
Notes.....	94



## IMPORTANT SAFEGUARDS

---

When using electrical appliances, basic safety precautions should always be followed including the following:

1. Read all instructions.
2. To protect against risk of electrical shock do not put food processor in water or other liquid.
3. Close supervision is necessary when any appliance is used by or near children.
4. Unplug from the outlet when not in use, before putting on or taking off parts, and before cleaning.
5. Avoid contacting moving parts.
6. Do not operate any appliance with a damaged cord or plug after the appliance malfunctions, or is dropped or damaged in any manner. Return appliance to the nearest authorized service facility for examination, repair or electrical or mechanical adjustment.
7. The use of attachments not recommended or sold by the manufacturer may cause fire, electric shock or injury.
8. Do not use outdoors.
9. Do not let cord hang over edge of table or counter.
10. Keep hands and utensils away from moving blades or discs while processing food to reduce the risk of severe injury to persons or damage to the food processor. A scraper may be used but must be used only when the food processor is not running.
11. Blades are sharp. Handle carefully.
12. To reduce the risk of injury, never place cutting blade or discs on base without first putting bowl properly in place.
13. Be certain cover is securely locked in place before operating appliance.
14. Never feed food by hand. Always use food pusher.
15. Do not attempt to defeat the cover interlock mechanism.
16. This product is designed for household use only.

## SAVE THESE INSTRUCTIONS



**Your safety and the safety of others is very important.**

We have provided many important safety messages in this manual and on your appliance. Always read and obey all safety messages.



This is the safety alert symbol.

This symbol alerts you to hazards that can kill or hurt you and others.

All safety messages will be preceded by the safety alert symbol and the word "DANGER" or "WARNING." These words mean:



**You will be killed or seriously injured if you don't follow instructions.**



**You can be killed or seriously injured if you don't follow instructions.**

All safety messages will identify the hazard, tell you how to reduce the chance of injury, and tell you what can happen if the instructions are not followed.



# KitchenAid® Food Processor Warranty — USA

This warranty extends to the purchaser and any succeeding owner for food processors operated in the 50 United States and the District of Columbia. For units operated in Puerto Rico, the Standard First Year Warranty applies (see page 7) and is a Limited Warranty because you must pay to ship the food processor to an Authorized KitchenAid Service Center.

<b>Length of Warranty:</b>	<b>KitchenAid Will Pay For:</b>	<b>KitchenAid Will Not Pay For:</b>
<p>One Year Full warranty from date of purchase.</p>	 <p>Total Replacement Warranty. (See page 2 for details) OR Replacement parts and repair labor costs to correct defects in materials and workmanship. Service must be provided by an Authorized KitchenAid Service Center.</p>	<p>A. Repairs when food processor is used in other than normal home use. B. Damage resulting from accident, alteration, misuse or abuse. C. Any shipping or handling costs to deliver your food processor to an Authorized Service Center. D. Replacement parts or repair labor costs for food processor operated outside the 50 United States, the District of Columbia or Puerto Rico.</p>

**KITCHENAID DOES NOT ASSUME ANY RESPONSIBILITY FOR INCIDENTAL OR CONSEQUENTIAL DAMAGES.** Some states do not allow the exclusion or limitation of incidental or consequential damages, so this exclusion may not apply to you. This warranty gives you specific legal rights and you may also have other rights which vary from state to state.



## How To Arrange For Service — USA Only

---

If the food processor is operated in the 50 United States or the District of Columbia, you may use either the Total Replacement Warranty program or our Standard First Year Warranty program. (See page 2 or page 7.)

Residents of Puerto Rico must use the Standard First Year Warranty program. *You may also use the information listed under Standard First Year Warranty to arrange for service after your warranty expires.*

## Standard First Year Warranty

---

### **(Required Warranty Service for Puerto Rico)**

Take the food processor or ship prepaid and insured to the nearest Authorized Service Center (nearest Authorized Service Center location can be obtained by calling **1-800-541-6390**, 8 a.m. to 8 p.m., Monday through Friday, 9 a.m. to 3 p.m., Saturday, Eastern time.) Your repaired food processor will be returned to you prepaid and insured. During the warranty period, all local service must be handled by an Authorized KitchenAid Service Center.

After the warranty period you may use any servicer you like, but we recommend Authorized KitchenAid Service. If you are unable to obtain satisfactory service in this manner, contact the Customer Satisfaction Center, KitchenAid Portable Appliances, P. O. Box 218, St. Joseph, Michigan 49085-0218. Call toll-free: **1-800-541-6390**, 8 a.m. to 8 p.m., Monday through Friday, 9 a.m. to 3 p.m., Saturday, Eastern time.

## How To Arrange For Service — Outside The USA

---

To arrange for service for units operated outside the 50 United States and the District of Columbia, consult your local KitchenAid dealer or the store where you purchased the food processor for information on how to obtain service locally.



## If You Need Service or Assistance

---

KEEP A COPY OF THE SALES RECEIPT SHOWING THE DATE OF PURCHASE. PROOF OF PURCHASE WILL ASSURE YOU OF IN-WARRANTY SERVICE.

**If your food processor should malfunction or fail to operate, check the following:**

- Is the food processor plugged in?
- Are all the interlock switches engaged?
- Is the fuse in the circuit to the food

processor in working order? If you have a circuit breaker box, be sure the circuit is closed.

- Try unplugging and waiting 15-20 minutes before re-plugging the food processor.
- If the problem is not due to one of the above items, see “How To Arrange For Service,” on page 7 .
- DO NOT return the food processor to the retailer as they do not provide service.

## Electrical Requirements

---

Volts: 120 A.C. only.  
Hertz: 60  
15-amp branch circuit.

The electrical rating listed on the unit is based on the attachment that draws the greatest load. Other attachments might draw significantly less power or current.

This appliance has a polarized plug (one blade is wider than the other). To reduce the risk of electrical shock, this plug will fit in a polarized outlet only one way. If the plug does not fit fully in the outlet, reverse the plug. If it still does not fit, contact a qualified electrician. Do not modify the plug in any way.





## Product Registration Card

---

Before you use your food processor, please fill out and mail your product registration card packed with the unit. This card will enable us to contact you in the unlikely event of a product safety notification, and assist us in complying with the provisions of the Consumer Product Safety Act. **THIS CARD DOES NOT VERIFY YOUR WARRANTY.**

Keep a copy of the sales receipt showing the date of purchase of your food processor. **PROOF OF PURCHASE WILL ASSURE YOU OF IN-WARRANTY SERVICE.**

Please complete the following for your personal records:

Model Number \_\_\_\_\_  
Date Purchased \_\_\_\_\_  
Store Name \_\_\_\_\_  
Address \_\_\_\_\_  
Phone \_\_\_\_\_

## How To Obtain Service

---

### **HOW TO OBTAIN SERVICE FOR UNITS OPERATED IN THE 50 UNITED STATES, DISTRICT OF COLUMBIA AND PUERTO RICO**

1. Call toll-free **1-800-541-6390** to arrange for service, or write to:  
Customer Satisfaction Center,  
KitchenAid Portable Appliances,  
P.O. Box 218, St. Joseph, MI  
49085-0218.
2. Look in your local phone directory Yellow Pages, under "Appliances, Small - Repair and Service."
3. Parts and Attachments for your food processor can also be obtained by calling **1-800-541-6390**.



# KFP600/KFPM650 Food Processor Features

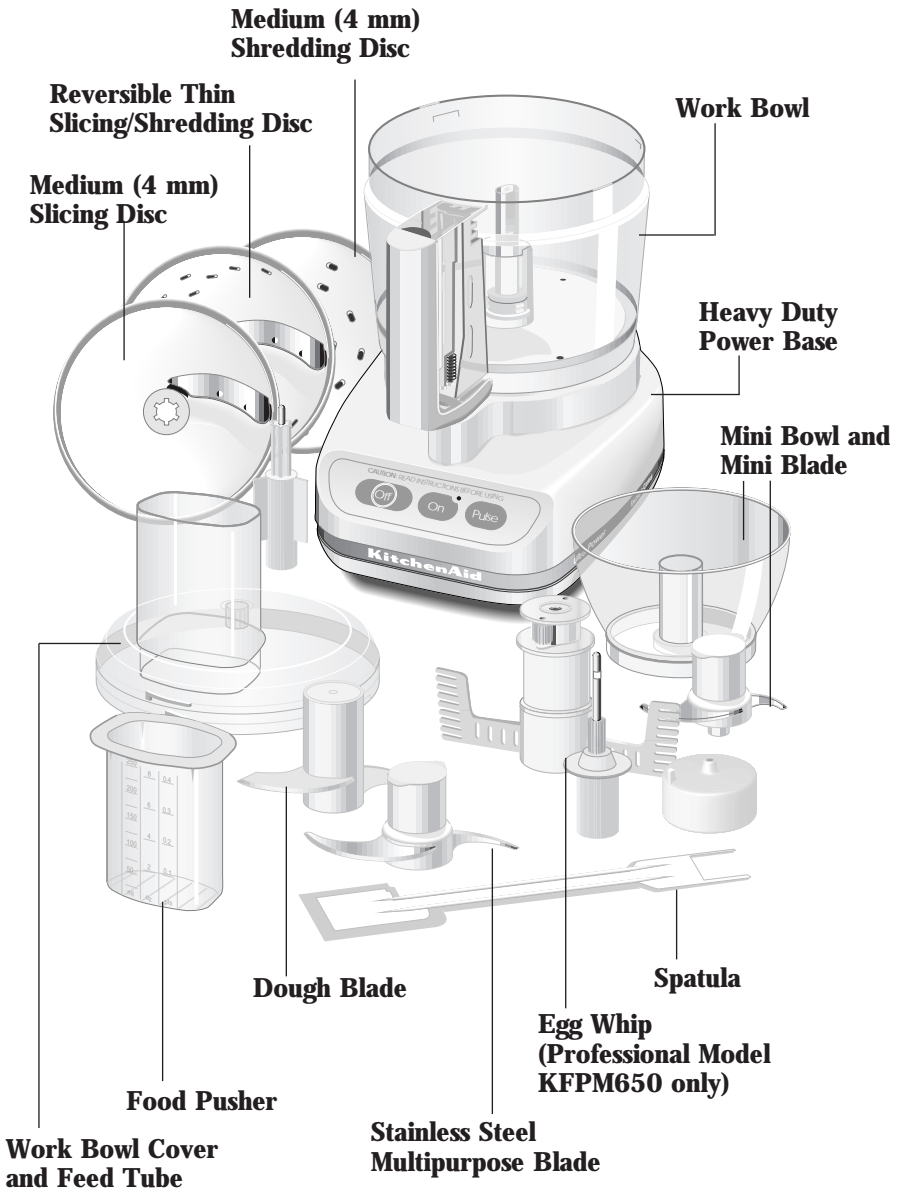



## KFP600/KFPM650 Food Processor Features

KitchenAid quality means this food processor was built and tested to meet high KitchenAid standards for optimum performance and long, trouble-free life.

**Food Pusher** features easy to read measurement markings.

**Work Bowl Cover and Feed Tube** are easy to assemble and clean.

**Work Bowl** features a smooth design for easy assembly and cleaning, and 11 cup capacity.

**Mini Bowl and Mini Blade** are perfect for small chopping and mixing jobs without soiling the large work bowl. The mini blade is made of the same high quality stainless steel as the multipurpose blade.

**Reversible Slicing/Shredding Disc** is a precision sharp slicing blade on one side and when turned over can shred most firm fruits, vegetables and cheeses into even uniform shreds. The shaft is removable for easy cleaning.



**Medium (4 mm) Shredding Disc** features larger shredding openings to coarsely shred firm fruits, vegetables, and cheeses.



**Medium (4 mm) Slicing Disc** gives you thicker, more substantial slices of most anything from delicate strawberries to partially frozen meat for stir-fry.



**Stainless Steel Multipurpose Blade** is the work horse blade used most often. It chops, minces, blends, mixes and emulsifies in a matter of seconds.

**Dough Blade** is specially designed for mixing and kneading yeast doughs.

**Optional Egg Whip** is designed to whip cream and egg whites for meringues, mousses, souffles and desserts. Standard with KFPM650.

**Heavy Duty Power Base** with Clean Touch™ ON/OFF/PULSE control pads and Electronic Processing Sensor to give you consistent speed every time. The smooth rounded base is easy-to-clean and features built-in cord storage.



## Assembling Your Food Processor

1. Before using your food processor for the first time, wash the work bowl, work bowl cover, mini bowl, feed tube pusher and blades either by hand or in the dishwasher, see Care and Cleaning, page 18.

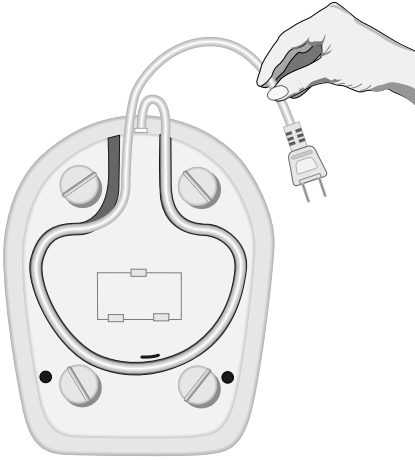

2. Uncoil needed length of cord from storage area beneath power base. Place power base on a dry level counter with the controls facing forward. Do not plug unit in until completely assembled.



3. Place work bowl on power base, fitting the center opening over the power base shaft, making sure the handle is just to the left of center.
4. Grasp the work bowl handle and turn to the right until it locks into position.





## Assembling Your Food Processor

### **⚠️ WARNING**

#### **Cut Hazard**

**Handle blades carefully.  
Failure to do so can result in cuts.**

#### 5. Select blade or disc.

•To use the multipurpose blade, place blade on power base shaft. It may be necessary to rotate blade slightly so that it is properly aligned and falls into place.

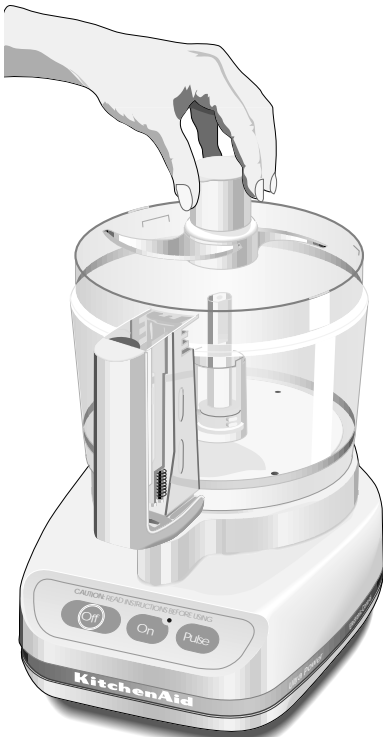

•To use the reversible thin (2mm) slicing/shredding disc, medium (4mm) shredding disc, or medium (4mm) slicing disc, place the disc stem on the power base shaft. Fit disc over the metal pin on the disc stem aligning the center opening of the disc with the ridges of the stem.

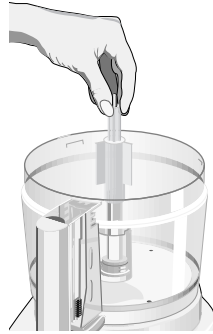



## Assembling Your Food Processor

- To use the Mini Bowl, place the Mini Bowl over the power base shaft. Fit the mini blade on the power base shaft. It may be necessary to rotate bowl and blade slightly so that they are properly aligned and fall into place.

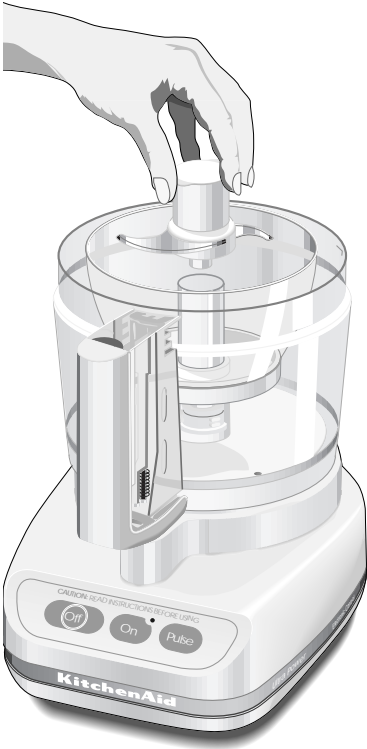

6. Place the work bowl cover on the work bowl with the feed tube just to the left of the work bowl handle. Grasp the feed tube and turn the cover to the right until it locks into place.



NOTE: Your KitchenAid® Food Processor

features a double interlock safety system to insure that the unit will not operate unless the work bowl and the work bowl cover are properly aligned on the power base.



NOTE: Never attach cover to the work bowl **before** the work bowl has been positioned on the power base. Damage to the work bowl may result.

7. Fit the pusher into the feed tube and plug unit into an electrical outlet.

NOTE: Never try to remove the work bowl **before** unlocking the work bowl cover (turning work bowl cover to the left). Damage to the work bowl may result.



## Egg Whip (Professional Model KFPM650 Only)

The Egg Whip is designed to whip egg whites or heavy cream for use as toppings or meringues. For best results, at least 1 cup of heavy cream or 3 egg whites should be whipped at a time. Whipping smaller quantities may not result in maximum volume.

### To Assemble Egg Whip:



1. Place Egg Whip stem on motor base shaft.
2. Fit the whip paddle on the stem and push down to engage the ridges of the stem with the gears of the paddle.
3. Fit cap over stem and push down to lock in place.

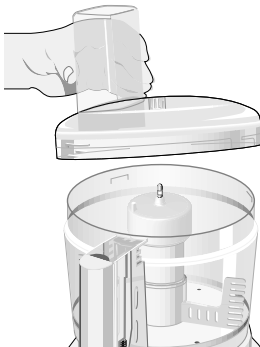

4. Place the work bowl cover on the work bowl with the feed tube just to the left of the handle. Be sure the center pin on whip fits into center opening of cover. Grasp the feed tube and turn to the right to engage the interlock. The Egg Whip is now ready to operate.
5. Press ON control pad and whip product to desired texture and volume.

### To Disassemble:

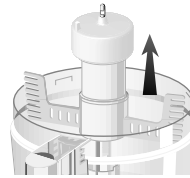

1. Unplug power base from electrical outlet. Remove work bowl cover by turning to the left.
2. Lift whip assembly straight up and off. Remove whipped product from work bowl.
3. Remove cap from whip assembly by pulling straight up. Push down on stem pin to remove stem from whip paddle.



# Operating Your Food Processor

<b>⚠ WARNING</b>	
	<b>Rotating Blade Hazard</b>
	<b>Always use food pusher.</b>
	<b>Keep fingers out of openings.</b>
	<b>Keep away from children.</b>
<b>Failure to do so can result in amputation or cuts.</b>	

- Before operating the food processor, be sure the work bowl, blades and work bowl cover are properly assembled on the food processor power base (see page 12).



- The Clean Touch™ OFF/ON/PULSE control pads take just a touch of your finger for optimum control and convenience in operating the food processor. By touching the ON control pad, the unit will run continuously and the red indicator light will glow until you touch the OFF control pad.

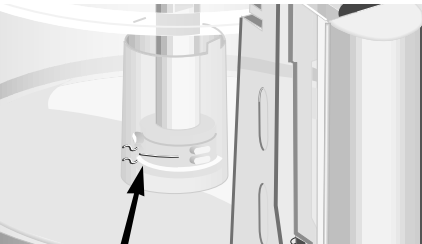

**NOTE:** Line on the work bowl indicates the maximum level of liquid that can be processed.

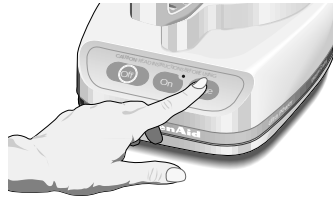

- The PULSE control pad helps to better regulate the degree of processing. By alternately pressing and releasing the PULSE pad, the food processor will be quickly turned on and off. The red indicator light will glow each time the PULSE pad is pressed. This allows you to control the exact length and frequency of processing since the KitchenAid® Food Processor performs in just a matter of seconds.

**NOTE:** If unit fails to operate, check to be sure that both the work bowl and cover are properly positioned on the power base. See **Assembling Your Food Processor page 12.**

- To stop your food processor, press the OFF control pad. The ON indicator light will go off. (The PULSE indicator light only glows when the pad is touched). Wait until the blade or disc comes to a complete stop before removing the work bowl cover. Be sure you push the OFF pad before removing the work bowl cover or unplugging the unit.

**AUTOMATIC BRAKE:** When the food processor is turned OFF, the automatic brake stops the action of the blade or disc within seconds. The brake provides an additional measure of safety as you remove the work bowl cover.





## Disassembling Your Food Processor

### **! WARNING**

**Cut Hazard**  
Handle blades carefully.  
Failure to do so can result in cuts.

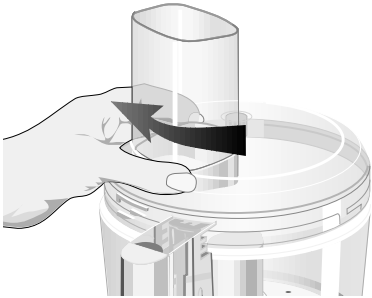

- Turn the work bowl cover to the left and remove.



- Turn the work bowl to the left to unlock it from the base. Lift up to remove.



- If using a disc, remove it before removing the bowl. Place two fingers under each side of the disc and lift it straight up. Remove the disc stem.

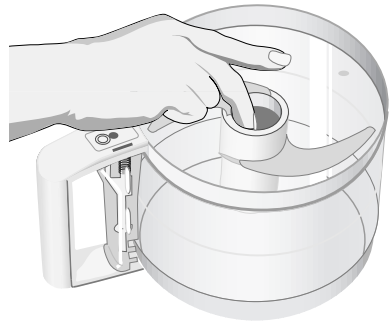

- If using the multipurpose blade, you can remove it from the work bowl before emptying the contents, or grasp the work bowl from the bottom placing one finger through the center opening to hold the blade in place. Remove contents of work bowl with spatula. If food sticks to blade, remove it with the spatula.



## Care and Cleaning

### **! WARNING**

#### **Cut Hazard**

**Handle blades carefully.  
Failure to do so can result in cuts.**

- Always make sure off pad has been pushed and unplug food processor before cleaning. Wipe food processor base with warm sudsy cloth; wipe clean with a damp cloth. Dry with a soft cloth.
- All the other parts of your KitchenAid® food processor are dishwasher safe. Be sure to load them away from exposed heating elements in the dishwasher. If washing the food processor parts by hand, avoid the use of abrasive cleansers or scouring pads. They may scratch or cloud the work bowl and cover. Thoroughly dry all parts after washing.
- Wipe cord with warm, sudsy cloth; then wipe clean with a damp cloth. Dry with a soft cloth. Re-coil cord in cord storage area on bottom of food processor base.



- Always store the work bowl and work bowl cover in the unlocked position when not in use to prevent damage to the interlock system.
- Disassembled discs, shafts, and blades should be stored in the storage box provided with your food processor, and in a safe location out of the reach of children.

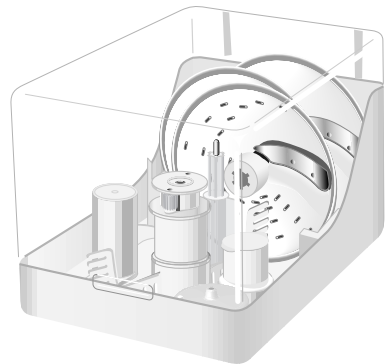



## Food Processing Tips

---

### **USING THE MULTIPURPOSE BLADE**

#### **To chop fresh fruits or vegetables:**

Peel, core, and/or remove seeds. Cut food in 1 to 1½-inch pieces. Process food to desired size, using short pulses, 1 to 2 seconds each time. Scrape sides of bowl, if necessary.

#### **To puree cooked fruits and vegetables (except potatoes):**

Add ¼ cup liquid from recipe per cup of food. Process food, using short pulses, until finely chopped. Then process continuously until reaching desired texture. Scrape sides of bowl, if necessary.

#### **To prepare mashed potatoes:**

Shred hot cooked potatoes, using the shredding disc. Exchange shredding disc for multipurpose blade. Add softened butter, milk, and seasonings. Pulse 3 to 4 times, 2 to 3 seconds each time, until smooth and milk is absorbed. Do not overprocess.

#### **To chop dried (or sticky) fruits:**

The food should be cold. Add ¼ cup flour from recipe per ½ cup dried fruit. Process fruit, using short pulses, until reaching desired texture.

#### **To finely chop citrus peel:**

With sharp knife, peel colored portion (without white membrane) from citrus. Cut peel in small strips. Combine peel with at least ½ cup granulated sugar from recipe. Process until finely chopped.

#### **To mince garlic or to chop fresh herbs or small quantities of vegetables:**

With processor running, add food through feed tube. Process until chopped. For best results, make sure work bowl is very dry before chopping garlic or fresh herbs.

#### **To chop nuts or make nut butters:**

Process up to 3 cups of nuts to desired texture, using short pulses, 1 to 2 seconds each time. For a coarser texture, process smaller batches, pulsing 1 or 2 times, 1 to 2 seconds each time. Pulse more often for finer texture. For nut butters, process continuously until smooth. Store in refrigerator.

#### **To chop cooked or raw meat, poultry or seafood:**

The food should be very cold. Cut in 1-inch pieces. Process up to 1 pound at a time to desired size, using short pulses, 1 to 2 seconds each time. Scrape sides of bowl, if necessary.

#### **To make bread, cookie or cracker crumbs:**

Break food into 1½ to 2-inch pieces. Process until fine. For larger pieces, pulse 2 to 3 times, 1 to 2 seconds each time. Then process until fine.

#### **To melt chocolate:**

Combine chocolate and sugar from recipe in work bowl. Process until finely chopped. Heat liquid from recipe. With processor running, pour hot liquid through feed tube. Process until smooth.



## Food Processing Tips

**To grate hard cheeses, such as Parmesan and Romano:** Never attempt to process cheese that cannot be pierced with the tip of a sharp knife. You can use the multipurpose blade to grate hard cheeses. Cut cheese in 1-inch pieces. Place in work bowl. Process, using short pulses, until coarsely chopped. Process continuously until finely grated.

### USING A SLICING OR SHREDDING DISC

**To cut julienne, or match stick, strips of vegetables and fruits:**

Cut food to fit feed tube horizontally. Position food horizontally in feed tube. Process, using even pressure to make plank-like slices. Re-stack slices and position vertically or horizontally in feed tube. Process, using even pressure.

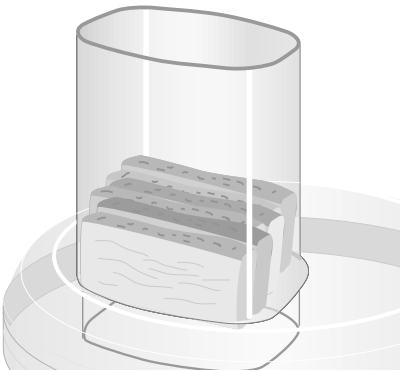
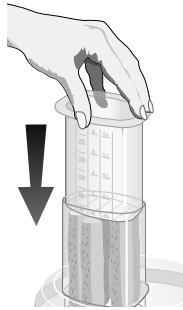

**To slice or shred fruits or vegetables that are long and relatively small in diameter, such as celery, carrots, and bananas:** Cut food to fit feed tube vertically or horizontally. Pack feed tube securely in order to keep food positioned properly. Process using even pressure.

**To slice or shred fruits and vegetables that are round, such as onions, apples, and green peppers:** Peel, core, and/or remove seeds. Cut in halves or quarters to fit feed tube. Position in feed tube. Some foods are easier to insert into tube from the bottom. Process, using even pressure.

**To slice or shred fruits and vegetables that are small, such as strawberries, mushrooms and radishes:** Position food vertically or horizontally in layers in feed tube. Fill feed tube in order to keep food positioned properly. Process, using even pressure.

**To shred spinach and other leaves:** **Stack leaves.** Roll up and stand roll up in feed tube. Process, using even pressure.



## Food Processing Tips

---

**To slice uncooked meat or poultry, such as stir-fry meats:** Cut or roll food to fit feed tube. Wrap and freeze food until hard to the touch, 30 minutes to 2 hours, depending on thickness of food. Check to be sure you can still pierce food with the tip of a sharp knife. If not, allow to thaw slightly. Process, using even pressure.

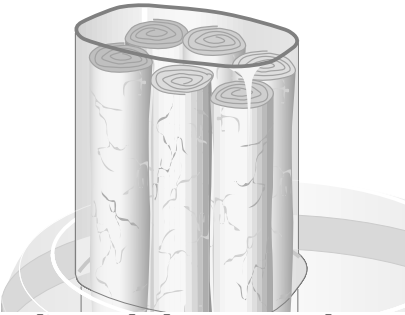

**To slice cooked meat or poultry, including salami, pepperoni, etc.:** Food should be very cold. Cut in pieces to fit feed tube. Process food, using firm, even pressure.

**To shred firm and soft cheeses:** Firm cheese should be very cold. For best results with soft cheeses, such as mozzarella, freeze 10 to 15 minutes before processing. Cut to fit feed tube. Process, using even pressure.

### USING THE DOUGH BLADE

**To make bread:** Use the dough blade for bread recipes using 2-3 cups flour. The multipurpose blade can be used for recipes calling for less than 3 cups flour.

### USING THE EGG WHIP

**To make egg white meringue:** Place 3 egg whites and  $\frac{1}{4}$  teaspoon cream of tartar in work bowl fitted with attachment (See page 15). Process until foamy, about 30 to 45 seconds. With processor running, slowly add  $\frac{1}{2}$  cup sugar through feed tube. Process until stiff peaks form, about  $2\frac{1}{2}$  to 3 minutes. Stop processor as necessary to check texture of mixture.

**To whip cream:** Place heavy cream in work bowl fitted with attachment (See page 15). Process 30 seconds. With processor running, add 2 tablespoons powdered sugar through feed tube. Process just until soft peaks form, about 30 to 40 seconds. Stop processor as necessary to check texture of mixture. With processor running, add  $\frac{1}{2}$  teaspoon vanilla, if desired, through feed tube. Process just until mixed. Do not overprocess.



## Helpful Hints

- Organize processing tasks to minimize bowl cleanup. Process dry or firm ingredients before liquid ingredients.
- Do not overfill work bowl or mini bowl. For thin mixtures, fill work bowl up to  $\frac{1}{2}$  to  $\frac{2}{3}$  full. For thicker mixtures, fill work bowl up to  $\frac{3}{4}$  full. For liquids fill up to the maximum level as described on page 16. When chopping, the work bowl should be no more than  $\frac{1}{3}$  to  $\frac{1}{2}$  full. Use the mini bowl for up to 1 cup of liquid or  $\frac{1}{2}$  cup solids.
- To capitalize on the speed of the processor, drop ingredients to be chopped through the feed tube while the processor is running, whether using the work bowl or the mini bowl.
- Position slicing and shredding discs so that cutting surface is to the right of the feed tube to allow blade a full rotation before contacting food.
- Different foods require varying degrees of pressure for best shredding and slicing results. In general, use light pressure for soft, delicate foods (strawberries, tomatoes, etc.), moderate pressure for medium foods (zucchini, potatoes, etc.), and firmer pressure for harder foods (carrots, apples, hard cheeses, partially frozen meats, etc.).
- Never process any food that is so hard or firmly frozen that it cannot be pierced with the tip of a sharp knife. Hard food can cause damage to the blade or power base. If a piece of hard food, such as carrot, becomes wedged or stuck on the blade, stop the processor and remove the blade. Carefully remove food from the blade.
- When preparing a cake or cookie batter or quick bread, use the multipurpose blade to cream fat and sugar first. Add dry ingredients last. Place nuts and fruit on top of flour mixture to prevent overchopping. Process nuts and fruits, using short pulses, until blended with other ingredients. Do not overprocess.
- Sometimes single foods, such as carrots or celery, fall over in the feed tube, resulting in an uneven slice. To minimize this, position food at right side of feed tube, or cut food in several pieces and put all pieces in feed tube together to help hold each other in position.

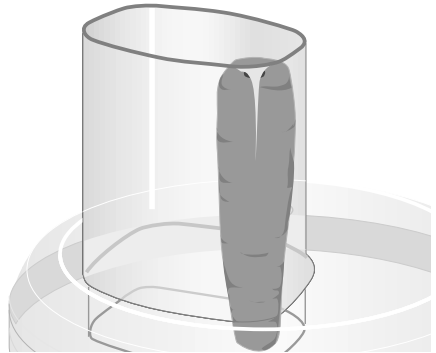



## Helpful Hints

---

- Create delicious “leftover” soups or salads with the processor. Use up that last carrot or a couple of green onions.
- Soft and medium-hard cheeses may spread out or roll up on the shredding disc. To avoid this, shred only well-chilled cheese.
- When shredded or sliced food piles up on one side of bowl, stop the processor and redistribute food, using a spatula.
- When food quantity reaches rim of work bowl, remove it. Then continue processing.
- A few larger pieces of food may remain on top of disc after slicing or shredding. If desired, cut these by hand and add to mixture.
- To remove mixtures from work bowl, use two or three fingers to steady the post in bowl center; position thumb on outer edge of bowl. This allows you to tip the bowl and scrape with the opposite hand.
- Your food processor is not designed to perform the following functions:
  - Grind coffee beans, grains, or hard spices.
  - Grind bones or other inedible parts of food.
  - Liquefy raw fruits or vegetables.
  - Slice hard-cooked eggs or unchilled meats.
- If any plastic parts should discolor due to the types of food processed, simply clean with a light bleach solution, following directions on the bleach container.

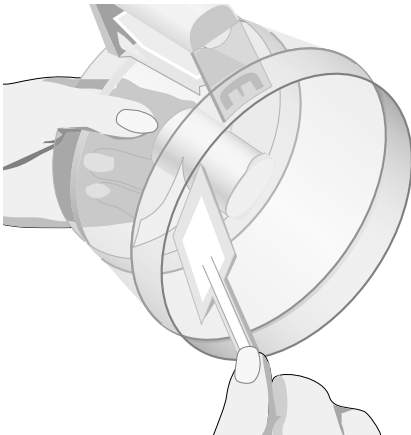

A decorative graphic featuring a central fork and knife icon, flanked by ornate, symmetrical scrollwork. The word "APPETIZERS" is written in red, serif, all-caps font across the center of the graphic.

# APPETIZERS





## STUFFED JUMBO MUSHROOMS

- 1 slice firm white bread, broken in 1-inch pieces
- 1 shallot, quartered
- 1 clove garlic
- 14 ounces jumbo mushrooms, cleaned
- 6 ounces ground sausage
- ½ teaspoon dry mustard
- 1 teaspoon Worcestershire sauce
- 1-2 tablespoons margarine or butter
- ½ cup freshly grated Parmesan cheese (see TIPS)

Position multipurpose blade in work bowl. Add bread. Process until finely crumbled, about 5 seconds. Set aside. With processor running, add shallot and garlic through feed tube. Process until finely chopped, about 5 seconds.

Remove stems from mushrooms. Add stems to work bowl. Pulse 3 times, about 1 second each time, until finely chopped.

In large skillet over medium heat, cook sausage until no longer pink. Drain well. Add shallot, garlic, and mushroom stems. Cook and stir for 4 to 5 minutes, until vegetables are tender.

Add sausage mixture to work bowl. Add bread crumbs, dry mustard, and Worcestershire sauce to work bowl. Process until thoroughly mixed, about 5 seconds.

Melt margarine in skillet over medium-low heat. Add mushroom caps. Cook for 1½ to 2 minutes on each side, until slightly soft.

Place on ungreased cookie sheets. Fill with sausage mixture. Sprinkle with Parmesan cheese. Bake at 350°F for 10 minutes, until hot and bubbly.

Yield: 16 to 18 mushrooms (2 to 3 mushrooms per serving).

Per serving: About 102 cal, 6 g pro, 5 g car, 7 g fat, 13 mg chol, 287 mg sod.



## SMOKY CHICKEN PATÉ

- 1 *tablespoon fresh rosemary leaves or 1 teaspoon crushed dried rosemary*
- 1 *onion, cut in 1-inch pieces*
- 4 *slices bacon*
- $\frac{3}{4}$  *pound chicken livers*
- $1\frac{1}{2}$  *cups cooked chicken, cut in 1-inch pieces*
- $\frac{1}{4}$  *pound (about 1 cup) ham, cut in 1-inch cubes*
- 3 *hard-cooked egg yolks*
- 2 *tablespoons brandy*
- $\frac{1}{2}$  *teaspoon ground coriander*
- $\frac{1}{4}$  *teaspoon ground cloves*
- $\frac{1}{4}$  *cup margarine or butter, softened*

Position mini bowl and mini blade in work bowl. With processor running, add rosemary through feed tube. Process until finely chopped, about 10 seconds. Set aside.

Exchange mini bowl and mini blade for multipurpose blade. Add onion. Pulse 3 times, about 1 second each time, until finely chopped.

In large skillet over low heat, cook bacon for 5 to 6 minutes. Do not crisp or brown bacon. Remove bacon. Reserve drippings in skillet. Cut bacon in 1-inch pieces. Set aside.

Add onion to bacon drippings. Cut chicken livers in half and remove connective tissue. Add to skillet. Cook onion and liver for 6 to 7 minutes, until tender and liver is slightly pink in center.

Add cooked chicken, ham, and egg yolks to work bowl. Process until finely chopped, about 10 seconds. Add all other ingredients to work bowl. Process until smooth and creamy, about 20 seconds, scraping bowl after 10 seconds, if necessary.

Yield:  $3\frac{1}{2}$  cups (32 2-tablespoon servings).

Per serving: About 54 cal, 5 g pro, 0 g car, 3 g fat, 74 mg chol, 85 mg sod.



## SEASONED CHEESE STRAWS

- 8 ounces American process cheese, room temperature, cut in 1-inch pieces
- 6 tablespoons butter, room temperature, cut in 1/2-inch pieces
- 1 teaspoon chili powder
- 1/4 teaspoon salt
- 1/8 teaspoon crushed red pepper
- 1 tablespoon milk or cream
- 1 teaspoon Worcestershire sauce
- 1 cup all-purpose flour

Position multipurpose blade in work bowl. Add all ingredients except flour. Process until thoroughly mixed, about 30 seconds, scraping bowl after 10 seconds, if necessary. Add flour. Pulse 5 to 6 times, about 2 seconds each time, just until flour is mixed. Scrape sides of bowl once, if necessary. Do not overmix.

Fit pastry bag with #5 star tip. Fill bag with cheese mixture. Pipe 3-inch strips onto ungreased cookie sheet, 1 inch apart. Bake at 350°F for 9 to 11 minutes, until edges start to brown.

Yield: 4 dozen (12 servings; 4 cheese straws per serving).

Per serving: About 144 cal, 4 g pro, 8 g car, 10 g fat, 29 mg chol, 293 mg sod.



## SPICY DEVEILED EGGS

---

- 1-2 *chipotle peppers\**
- $\frac{1}{4}$  *cup packed fresh cilantro leaves*
- $\frac{1}{2}$  *small onion, cut in 1-inch pieces*
- 6 *hard-cooked eggs, peeled, cut in half lengthwise*
- 2 *tablespoons reduced-calorie mayonnaise*
- $\frac{1}{4}$  *teaspoon salt*

Soak peppers for 10 minutes in  $\frac{1}{4}$  cup boiling water.

Position mini bowl and mini blade in work bowl. With processor running, add cilantro through feed tube. Process until finely chopped, about 5 seconds. Set aside.

Exchange mini bowl and mini blade for multipurpose blade. Cut soaked peppers in  $\frac{1}{2}$ -inch pieces, reserving liquid. Add peppers and onion to work bowl. Process until finely chopped, about 10 to 15 seconds. Add egg yolks, mayonnaise, 1 tablespoon reserved soaking liquid, salt, and cilantro. Process until smooth, about 5 to 10 seconds, scraping sides of bowl, if necessary.

Spoon or pipe into egg white halves.

Yield: 12 deviled egg halves (6 servings; 2 halves per serving).

\* Chipotle peppers are dried, smoked jalapeno peppers.

Per serving: About 97 cal, 7 g pro, 3 g car, 6 g fat, 214 mg chol, 182 mg sod.



## CHEESY CARAMELIZED ONION SQUARES

- 4 ounces Monterey Jack cheese
- 2 medium onions
- 2 teaspoons vegetable oil
- 2 tablespoons strawberry-apple jelly or apply jelly
- 2 teaspoons dry sherry
- 1 sheet (from 17¼-oz. pkg.) frozen puff pastry, thawed
- 1 egg white, beaten
- ½ cup freshly grated Parmesan cheese (see TIPS)

Position 4 mm shredding disc in work bowl. Shred Monterey Jack cheese. Remove and set aside. Wipe out bowl if necessary.

Exchange shredding disc for reversible slicing/shredding disc to slice. Add onions, cut to fit feed tube, if necessary. Process to slice.

Heat oil in large skillet over medium-high heat, until oil sizzles. Cook and stir for 5 minutes, until onions are limp and starting to brown. Add jelly and sherry. Cook and stir for 1 minute, until onions are coated and liquid is evaporated. Set aside.

Roll puff pastry to 12 x 12-inch square. Place on ungreased cookie sheet. Cut a ½-inch strip from each edge of pastry. Brush edges of square with egg white. Fit strips on outside edges of pastry, cutting at ends to fit.

Bake at 375°F for 5 to 7 minutes, until pastry puffs and edges start to brown. Lightly prick top with fork. Sprinkle Parmesan cheese evenly over pastry. Top evenly with onions. Sprinkle Monterey Jack cheese over onions. Bake 15 minutes at 375°F for 15 to 17 minutes, until pastry is golden brown and cheese is melted and bubbly. Cool slightly. Cut in squares.

Yield: 36 squares (12 3-piece servings).

Per serving: About 184 cal, 6 g pro, 13 g car, 12 g fat, 12 mg chol, 277 mg sod.



## SHRIMP DILL DIP

- 1/4 medium onion, cut in 1-inch pieces*
- 1 package (8 oz.) light cream cheese, softened*
- 1/2 cup light sour cream*
- 1/4 cup reduced-calorie mayonnaise*
- 1 teaspoon dill*
- 1 teaspoon horseradish*
- 1/4 teaspoon hot pepper sauce*
- 1 cup (4 oz.) small fully cooked shrimp*

Position multipurpose blade in work bowl. Add onion. Process until finely chopped, about 5 seconds. Add all remaining ingredients, except shrimp. Process until smooth and creamy, about 20 seconds, scraping bowl after 10 seconds, if necessary. Add shrimp. Pulse 3 times, about 1 second each time, until coarsely chopped.

Yield: 2 cups (16 2-tablespoon servings).

Per serving: About 68 cal, 5 g pro, 2 g car, 4 g fat, 40 mg chol, 142 mg sod.

## SALSA VERDE

- 1-2 mild yellow chili peppers, seeded and cut in 1/2-inch pieces*
- 1 clove garlic, quartered*
- 1/4 cup well packed fresh cilantro leaves*
- 4 green onions, cut in 1-inch pieces, including green tops*
- 12 ounces fresh tomatillos, husk removed, cut into 1-inch pieces*
- 1/2 red bell pepper, cut into 1-inch pieces*
- 1 cup fresh, frozen, or canned pineapple chunks*
- 3 tablespoons lime juice*
- 2 tablespoons sugar*

Position multipurpose blade in work bowl. With processor running, add chili peppers, garlic, and cilantro through feed tube. Process until finely chopped, about 10 seconds. Remove to large mixing bowl.

Add green onions to work bowl. Process until finely chopped, about 5 seconds. Add to mixing bowl.

Add tomatillos to work bowl. Pulse 8 to 10 times, about 1 second each time, until coarsely chopped. Add to mixing bowl.

Add bell pepper to work bowl. Pulse 4 to 5 times, about 1 second each time, until coarsely chopped. Add to mixing bowl.

Add pineapple pieces to work bowl. Process until finely chopped, about 5 to 7 seconds. Add to mixing bowl.

Add lime juice and sugar to mixing bowl. Stir to mix.

Serve with tortilla chips or as a condiment on grilled meats.

Yield: 2 1/2 cups (10 1/4-cup servings).

Per serving: About 32 cal, 1 g pro, 8 g car, 0 g fat, 0 mg chol, 6 mg sod.



## VEGETABLE TERRINE

- 2 medium carrots, cut in 2½-inch lengths
- ¼ cup water
- 1 tablespoon sugar
- 1 tablespoon lemon juice
- 1 medium onion, cut in 1-inch pieces
- 10 ounces (about 8 cups packed) spinach leaves, washed and dried
- 2-3 tablespoons peanut oil
- ¾ cup fat-free egg substitute or 3 eggs
- 1½ cups cooled cooked rice
- ¼-½ teaspoon cinnamon
- ⅛-¼ teaspoon nutmeg
- ¼ teaspoon salt
- ⅛ teaspoon pepper

Cut 8½ x 12-inch piece of foil. Fit in bottom and up long sides of 8½ x 4½ x 2½-inch baking pan, extending foil over sides. Butter foil.

Position reversible slicing/shredding disc in work bowl to slice. Add carrots lengthwise to feed tube. Using firm pressure, slice carrots.

In large skillet, bring water, sugar, and lemon juice to a boil. Add carrots. Cover. Cook for 5 minutes, until crisp-tender. Drain. Set aside. Wipe out skillet.

Exchange reversible slicing/shredding disc for multipurpose blade. Add onion. Pulse 4 times, about 1 minute each time, until finely chopped.

Heat 1 tablespoon oil in skillet over medium-high heat, until oil sizzles. Add onion. Cook for 3 minutes, until tender. Return to work bowl.

Heat 1 to 2 tablespoons oil in skillet, until oil sizzles. Add half of spinach. Cook and stir until slightly wilted. Add remaining spinach. Continue cooking and stirring until wilted.

Reduce heat to low. Cover. Cook 1 minute. Cool slightly.

Add to work bowl. Process until smooth, about 10 seconds. With processor running, add egg substitute through feed tube. Process 10 seconds. Add cooked rice, cinnamon, nutmeg, salt, and pepper. Process until smooth, about 45 to 60 seconds.

Pour half of spinach mixture into prepared pan; smooth top. Layer cooked carrots evenly over spinach. Top with remaining spinach mixture; smooth top. Cover pan with foil. Bake at 325°F for 50 to 60 minutes, until spinach is set and knife inserted in center comes out clean. Cool. Remove from pan, using foil to lift. Slice. Serve slightly warm or cold.

Yield: 8 servings.

Per serving: About 118 cal, 4 g pro, 17 g car, 4 g fat, 0 mg chol, 293 mg sod.



## GORGONZOLA CHEESE BALL

- 1/2 cup shelled pistachio nuts or pecans*
- 1 shallot, quartered*
- 4 ounces white Cheddar cheese, cut in 1/2-inch cubes*
- 6 ounces Gorgonzola or blue cheese, crumbled*
- 4 ounces light cream cheese, slightly softened, cut in 1-inch slices*
- 1/4 cup (1/2 stick) margarine or butter, slightly softened, cut in 1/2-inch slices*
- 2 tablespoons brandy, cognac, or cream*
- 1 teaspoon Worcestershire sauce*

Position multipurpose blade in work bowl. Add nuts. Pulse 3 to 4 times, about 1 second each time, until nuts are chopped. Set aside.

With processor running, add shallot through feed tube. Process to finely chop, about 5 seconds, scraping sides of bowl, if necessary. Add Cheddar cheese. Pulse 4 to 5 times, about 2 seconds each time, until crumbly. Add remaining ingredients. Process until creamy, about 40 seconds, scraping sides of bowl after 20 seconds, if necessary.

Spread nuts on waxed paper. Spoon cheese onto a second sheet of waxed paper. Shape roughly into a ball with a rubber scraper. (If too soft, refrigerate 1/2 hour.) Roll ball in nuts. Wrap. Chill overnight to blend flavors. Serve at room temperature for best flavor.

Yield: 2 1/4 cups (36 1-tablespoon servings).

Per serving: About 60 cal, 3 g pro, 1 g car, 5 g fat, 12 mg chol, 113 mg sod.





## CHEESY HOT SALMON DIP

---

- 4 *green onions, cut in 1-inch pieces, including green tops*
- 1 *pkg. (8 oz.) light cream cheese, at room temperature, cut in 1-inch pieces*
- 4 *ounces Camembert or Brie cheese, cut in 1-inch pieces*
- 1 *can (7½ oz.) red salmon, (bones, skin, and dark meat removed)*
- 1 *jar (6 oz.) marinated artichoke hearts, drained*

Position multipurpose blade in work bowl. Add green onions. Process to coarsely chop, about 3 to 4 seconds. Add cream cheese and Camembert cheese. Process until creamy, about 10 seconds. Add salmon. Process to mix, about 8 to 10 seconds. Add artichoke hearts. Pulse 5 times, about 1 second each time, until coarsely chopped. Spread in 10-inch pie plate or quiche pan.

Bake at 325°F for 10 minutes, until heated thoroughly. Serve with vegetable dippers, crackers, or chips.

Yield: 3 cups (24 2-tablespoon servings).

Per serving: About 53 cal, 4 g pro, 1 g car, 4 g fat, 14 mg chol, 162 mg sod.

A decorative graphic featuring a central icon of a fork and a knife. The fork is on the left and the knife is on the right, both pointing upwards. This icon is set against a background of stylized, light gray, swirling flourishes that resemble calligraphic or Art Deco-style scrollwork.

# SALADS AND DRESSINGS



## CHICKEN CHUTNEY SALAD

- 1 *small carrot, cut in 4 pieces*
- 3 *cups cooked chicken chunks*
- 2 *medium pears or 1 medium mango*
- 1 *medium green bell pepper*
- 1/2 *small (about 1/2 lb.) red cabbage*

### **Dressing**

- 6 *tablespoons reduced-calorie mayonnaise*
- 1/4 *cup chutney*
- 3 *tablespoons skim or low-fat milk*
- 1 *teaspoon curry powder*

Position multipurpose blade in work bowl. Add carrot. Process until finely chopped, about 10 seconds. Set aside. Add chicken. Process until coarsely chopped, about 10 to 15 seconds. Set aside.

Exchange multipurpose blade for 4 mm slicing disc. Add pears or mango. Process to slice. Set aside. Add bell pepper. Process to slice. Set aside.

Exchange slicing disc for reversible slicing/shredding disc to slice. Add cabbage. Process to slice.

In small bowl, combine dressing ingredients. To assemble salads, divide cabbage among 6 salad plates. Alternate pear or mango slices and pepper slices around plate. Fill center with chicken. Spoon dressing over salad. Sprinkle with chopped carrot.

Yield: 6 servings.

Per serving: About 259 cal, 22 g pro, 18 g car, 10 g fat, 63 mg chol, 179 mg sod.

## SPICY JICAMA SALAD

- 1 *medium (about 1 lb.) jicama, peeled*
- 2 *ribs celery, cut in 2 1/2-inch pieces*
- 6 *small lettuce leaves*

### **Dressing**

- 1/3 *cup no-fat mayonnaise*
- 1/2 *small red bell pepper, cut in 6 pieces*
- 4 *teaspoons Dijon mustard*

Position 4 mm slicing disc in work bowl. Add jicama. Process to slice. Remove to mixing bowl.

Add celery to work bowl. Process to slice. Add to mixing bowl.

Exchange slicing disc for mini bowl and mini blade. Add dressing ingredients. Pulse 5 to 6 times, about 1 second each time, until mixed thoroughly.

Pour dressing over jicama and celery. Toss gently. Serve on lettuce-lined plates.

Yield: 6 servings.

Per serving: About 62 cal, 2 g pro, 13 g car, 0 g fat, 0 mg chol, 230 mg sod.



## CHOPPED CHICKEN AND VEGETABLE SALAD

---

3 cups cooked chicken  
chunks

1 cup cooked wild rice

1 small red bell  
pepper, cut in  
4 pieces

1 rib celery, cut in  
4 pieces

6 green onions, cut in  
1-inch pieces

### Spicy Dressing

$\frac{1}{4}$  cup vegetable oil

4 teaspoons red wine  
vinegar

4 teaspoons Dijon  
mustard

$\frac{1}{4}$ - $\frac{1}{2}$  teaspoon hot pepper  
sauce

$\frac{1}{8}$ - $\frac{1}{4}$  teaspoon black pepper

Position multipurpose blade in work bowl. Add chicken. Process until coarsely chopped, about 10 to 15 seconds. Remove to medium mixing bowl. Add rice to mixing bowl.

Add bell pepper, celery, and onions to work bowl. Pulse 5 to 8 times, about 1 second each time, until vegetables are coarsely chopped. Add to mixing bowl. Stir to mix.

Exchange multipurpose blade for mini bowl and mini blade. Add dressing ingredients. Process until smooth, about 10 to 12 seconds. Pour dressing over chicken mixture. Toss to coat.

Yield: 4 servings.

Per serving: About 371 cal, 34 g pro, 12 g car, 21 g fat, 88 mg chol, 164 mg sod.

## CHINESE COLESLAW

---

$\frac{1}{2}$  medium (about 1  
lb.) Napa cabbage

1 small red onion

3 tablespoons  
sunflower seeds

1 package (3 oz.)  
ramen noodles

$\frac{1}{4}$  cup vegetable oil

2 tablespoons vinegar

2 tablespoons sugar

Position reversible slicing/shredding disc in work bowl to slice. Add cabbage and onion. Process to slice. Remove to large serving bowl. Add sunflower seeds.

Remove seasoning packet from noodles. Set aside. Crumble noodles. Add to serving bowl.

In small mixing bowl, combine oil, vinegar, sugar, and contents of noodle seasoning packet. Stir to mix. Pour over cabbage. Toss to coat.

Yield: 8 servings.

Per serving: About 111 cal, 2 g pro, 7 g car, 9 g fat, 0 mg chol, 79 mg sod.



## RED CABBAGE SLAW

- 1/2 medium (about 3/4 lb.) red cabbage*
- 1 medium Granny Smith or golden delicious apple, cored, cut in 4 pieces each*

### **Dressing**

- 1/2 cup nonfat yogurt*
- 1/4 cup nonfat mayonnaise*
- 2 tablespoons fresh lemon juice*
- 1 1/2 teaspoons sugar*

Position reversible slicing/shredding disc in work bowl to slice. Add cabbage. Process to slice. Remove to large mixing bowl.

Exchange reversible slicing/shredding disc for multipurpose blade. Add apple. Pulse 8 to 10 times, about 1 second each time, until finely chopped. Add to mixing bowl.

In small mixing bowl, combine dressing ingredients. Pour over cabbage and apple. Toss to coat.

Yield: 6 servings.

Per serving: About 60 cal, 2 g pro, 14 g car, 0 g fat, 0 mg chol, 177 mg sod.

## SHREDDED SUMMER SQUASH SALAD

- 3 small (about 3/4 lb.) green zucchini, cut in 2 1/2-inch pieces*
- 2 small (about 1/2 lb.) yellow zucchini, cut in 2 1/2-inch pieces*

### **Dressing**

- 1/3 cup vegetable oil*
- 3 tablespoons red wine vinegar*
- 1/4 small red bell pepper*
- 3 green onions, cut in 1-inch pieces*
- 2 tablespoons loosely packed parsley leaves*
- 1/4 teaspoon garlic salt*
- 1/4 teaspoon dry mustard*

Position 4 mm shredding disc in work bowl. Add zucchini. Process to shred. Remove to medium mixing bowl.

Exchange shredding disc for multipurpose blade. Add dressing ingredients. Process until almost smooth, about 10 to 12 seconds. Pour dressing over zucchini. Toss to coat.

Yield: 6 servings.

Per serving: About 126 cal, 1 g pro, 4 g car, 12 g fat, 0 mg chol, 45 mg sod.



## CARROT AND DATE SALAD

- 5 *medium carrots, cut in 2½-inch pieces*
- ½ *cup chopped dates*
- 4 *small lettuce leaves*
- 3 *tablespoons toasted pecans*

### **Dressing**

- ¼ *cup nonfat mayonnaise*
- 2 *tablespoons orange juice*
- ½ *teaspoon grated orange peel*

Position 4 mm shredding disc in work bowl. Add carrots. Process to shred. Remove to medium mixing bowl. Add dates.

Exchange shredding disc for mini bowl and mini blade. Add dressing ingredients. Process until smooth, about 10 to 12 seconds.

Pour dressing over carrots and dates. Toss to coat. Serve on lettuce-lined plates. Sprinkle with pecans.

Yield: 4 servings.

Per serving: About 157 cal, 2 g pro, 32 g car, 4 g fat, 0 mg chol, 253 mg sod.

## HOT CHICKEN SALAD

- 3 *cups cooked chicken chunks*
- 1 *hard-cooked egg, peeled, halved*
- ⅓ *cup whole ripe olives, pitted*
- 3 *green onions, cut in 1-inch pieces*
- 2 *ribs celery, cut in 2½-inch pieces*
- ¾ *cup reduced-calorie mayonnaise*
- 1 *jar (2 oz.) diced pimientos, drained*
- 1 *tablespoon fresh lemon juice*
- ¼ *teaspoon salt*
- ⅛ *teaspoon black pepper*
- ¼ *cup sliced almonds*

Spray 8 x 8-inch baking dish with no-stick cooking spray.

Position multipurpose blade in work bowl. Add chicken, egg, olives, and onions. Pulse 8 to 10 times, about 1 second each time, until coarsely chopped. Remove to large mixing bowl.

Exchange multipurpose blade for 4 mm slicing disc. Add celery. Process to slice. Add to mixing bowl.

In small mixing bowl, combine mayonnaise, pimientos, lemon juice, salt, and pepper. Stir to mix. Add to mixing bowl. Stir to coat.

Spread in baking dish. Sprinkle with almonds. Bake at 375°F for 20 to 25 minutes, until thoroughly heated.

Yield: 4 servings.

Per serving: About 408 cal, 35 g pro, 9 g car, 26 g fat, 152 mg chol, 626 mg sod.



## HOT POTATO SALAD

- 4 *medium potatoes, boiled, peeled*
- 1 *medium onion, cut in 4 pieces*
- 4 *slices bacon*
- 4 *teaspoons all-purpose flour*
- 4 *teaspoons sugar*
- $\frac{1}{2}$  *teaspoon celery seed*
- $\frac{1}{4}$  *teaspoon black pepper*
- $\frac{1}{2}$  *cup water*
- $\frac{1}{4}$  *cup vinegar*
- 1 *jar (2 oz.) diced pimientos, drained*

Position 4 mm slicing disc in work bowl. Add potatoes. Process to slice. Set aside.

Exchange slicing disc for multipurpose blade. Add onion. Pulse 8 to 10 times, about 1 second each time, until coarsely chopped.

In large skillet over medium-high heat, cook bacon for 3 to 4 minutes, until crisp. Remove, drain and crumble. Reserve 1 tablespoon drippings in skillet.

Add onion. Cook and stir for 2 to 3 minutes, until tender. Add flour, sugar, celery seed, and pepper. Stir to combine. Reduce heat to medium-low. Cook and stir until mixture is bubbly. Add water and vinegar. Heat to boiling, stirring constantly. Boil for 1 minute. Add potatoes, bacon, and pimientos. Stir gently to combine. Heat until warm.

Yield: 6 servings.

Per serving: About 123 cal, 3 g pro, 23 g car, 2 g fat, 4 mg chol, 74 mg sod.



## VEGETABLE CRUNCH SALAD

$\frac{1}{3}$  *small head (about  $\frac{1}{2}$  lb.) cauliflower, cut into florets*

*1 stalk (about  $\frac{3}{4}$  lb.) broccoli, cut into florets*

*2 medium carrots, cut in  $2\frac{1}{2}$ -inch pieces*

### **Vinaigrette Dressing**

$\frac{1}{4}$  *cup vegetable oil*

*2 tablespoons red wine vinegar*

*1 tablespoon fresh lemon juice*

*2 green onions, cut in 1-inch pieces*

$\frac{3}{4}$  *teaspoon prepared mustard*

$\frac{1}{2}$  *teaspoon sugar*

$\frac{1}{4}$  *teaspoon black pepper*

Position multipurpose blade in work bowl. Add cauliflower. Pulse 6 to 8 times, about 1 second each time, until coarsely chopped. Remove to large mixing bowl.

Add broccoli to work bowl. Pulse 6 to 8 times, about 1 second each time, until coarsely chopped. Add to mixing bowl.

Exchange multipurpose blade for 4 mm shredding disc. Add carrots. Process to shred. Add to mixing bowl.

Exchange shredding disc for mini bowl and mini blade. Add vinaigrette dressing ingredients. Process until smooth, about 20 to 25 seconds. Pour dressing over vegetables. Toss to coat.

Yield: 6 servings.

Per serving: About 109 cal, 2 g pro, 6 g car, 9 g fat, 0 mg chol, 29 mg sod.





## CREAMY ORANGE DRESSING

---

- 1 package (8 oz.)  
*light cream cheese,  
softened*
- 1 can (6 oz.) frozen  
*orange juice  
concentrate, thawed*
- 2 tablespoons *skim or  
low-fat milk*
- 1½ teaspoons *sugar*
- ¼ cup *pecans*

Position multipurpose blade in work bowl. Add cream cheese, orange juice concentrate, milk, and sugar. Process until very smooth, about 35 to 45 seconds. Add pecans. Pulse 2 to 3 times, about 1 second each time, until pecans are coarsely chopped.

Serve over fruit, angel food cake, or pound cake.

Yield: 1¼ cups (30 1-tablespoon servings).

Per serving: About 36 cal, 1 g pro, 3 g car, 2 g fat, 6 mg chol, 31 mg sod.

## SPICY MEXICAN DRESSING

---

- ⅔ cup *mild salsa*
- ¼ cup *loosely packed  
cilantro leaves*
- 3 tablespoons *white  
wine vinegar*
- 2 tablespoons *fresh  
lime juice*
- 1 tablespoon *vegetable oil*
- 1 tablespoon *prepared  
mustard*
- ¼ teaspoon *sugar*
- ⅛ teaspoon *black  
pepper*

Position multipurpose blade in work bowl. Add all ingredients. Process until almost smooth, about 10 to 12 seconds. Refrigerate at least 1 hour to blend flavors.

Yield: 1 cup (16 1-tablespoon servings).

Per serving: About 13 cal, 0 g pro, 1 g car, 1 g fat, 0 mg chol, 117 mg sod.

A decorative graphic featuring a central fork and knife icon, flanked by stylized, symmetrical flourishes that resemble the letters 'S' and 'D'.

# SOUPS AND SANDWICHES



## CREAMY BROCCOLI SOUP

- 2 *tablespoons fresh parsley*
- 4 *ounces Cheddar cheese*
- 1 *small onion, cut in 1-inch pieces*
- 1/2 *rib celery, cut in 1-inch pieces*
- 1 *tablespoon vegetable oil*
- 1 *pound broccoli*
- 3 *cups reduced-sodium chicken broth*
- 2 *teaspoons Dijon mustard*
- 1 *teaspoon curry powder*
- 1/8 *teaspoon black pepper*
- 2 *cups skim or low-fat milk*
- 3 *tablespoons all-purpose flour*

Position mini bowl and mini blade in work bowl. With processor running, add parsley through feed tube. Process until coarsely chopped, about 5 seconds. Set aside.

Exchange mini bowl and mini blade for 4 mm shredding disc. Add cheese. Process to shred. Set aside.

Exchange shredding disc for multipurpose blade. Add onion and celery. Process until finely chopped, about 5 seconds.

Heat oil in large saucepan or Dutch oven over medium heat, until oil sizzles. Add onion and celery to saucepan. Cook for 2 to 3 minutes, until crisp-tender, stirring occasionally.

Cut stems from broccoli. Cut florets into small pieces. Cut tough portion from stems. Cut remaining stems in half lengthwise and in 1-inch pieces. Add stem pieces to work bowl. Process until coarsely chopped, about 5 seconds. Remove to saucepan.

Add florets, half at a time, to work bowl. Pulse 5 times, about 1 second each time, until coarsely chopped. Remove to saucepan. Repeat with remaining broccoli florets.

Add chicken broth, parsley, mustard, curry powder, and pepper to saucepan. Bring to a boil over medium-high heat. Reduce heat to medium-low. Cover. Cook for 15 to 20 minutes, until vegetables are tender. Pour into large bowl to cool slightly.

Add half of broccoli mixture to work bowl. Process until smooth, about 10 seconds. Return to saucepan. Repeat with remaining broccoli mixture.

In small bowl, combine milk and flour. Stir until smooth. Add to saucepan. Bring to a boil. Cook for 1 minute, stirring constantly. Reduce heat to low. Add cheese. Cook and stir until thoroughly heated.

Yield: 6 cups (6 1-cup servings).

Per serving: About 172 cal, 11 g pro, 12 g car, 9 g fat, 21 mg chol, 346 mg sod.



## CREAMY LENTIL SOUP

- 1/2 cup loosely packed fresh parsley leaves*
- 3 slices bacon*
- 1 large carrot, cut in 3-inch pieces*
- 1 clove garlic, quartered*
- 2 ribs celery, cut in 1-inch pieces*
- 1 medium onion, cut in 1-inch pieces*
- 2 cups lentils, rinsed, sorted*
- 6 1/2 cups reduced-sodium chicken broth, divided*
- 1 can (8 oz.) tomato sauce*
- 1/2 teaspoon salt*
- 1/4 teaspoon black pepper*
- 1 cup plain yogurt*

Position mini bowl and mini blade in work bowl. With processor running, add parsley through feed tube. Process until finely chopped, about 15 to 20 seconds. Set aside.

In large skillet over medium-high heat, cook bacon for 3 to 4 minutes, until crisp. Remove bacon; crumble and set aside. Reserve drippings in skillet.

Exchange mini bowl and mini blade for reversible slicing/shredding disc to slice. Add carrot. Process to slice. Add to skillet.

Exchange reversible slicing/shredding disc for multipurpose blade. With processor running, add garlic through feed tube. Process to finely chop, about 10 seconds. Add celery and onion. Process to finely chop, about 5 seconds. Add to skillet.

Cook over medium-high heat for 4 to 5 minutes, until vegetables are crisp-tender. Add lentils and 3 1/2 cups broth. Cook for 25 to 30 minutes, until lentils are tender.

Place half of lentil mixture in work bowl. Process to puree, about 30 to 45 seconds. Pour into large saucepan or Dutch oven. Repeat with remaining lentil mixture.

Add remaining 3 cups broth, tomato sauce, salt, and pepper to saucepan. Bring to a boil. Reduce heat to low. Cook for 10 to 15 minutes, until flavors are blended.

Serve in bowls with yogurt swirled on top. Add parsley and crumbled bacon.

Yield: 8 cups (8 1-cup servings).

Per serving: About 134 cal, 10 g pro, 19 g car, 3 g fat, 4 mg chol, 623 mg sod.



## FRENCH ONION SOUP EN CASSEROLE

- 4 ounces Gruyere or Swiss cheese
- 3 large onions
- 2 tablespoons margarine or butter
- 1 tablespoon all-purpose flour
- ½ teaspoon black pepper
- 5 cups low-sodium beef broth
- ½ cup dry sherry
- 1 teaspoon Worcestershire sauce
- 2 cups large home-style croutons or 6 slices toasted French bread
- 2 ounces freshly grated Parmesan cheese (see TIPS)

Position 4 mm shredding disc in work bowl. Add Gruyere cheese. Process to shred. Set aside.

Exchange shredding disc for reversible slicing/shredding disc to slice. Add onions, cut to fit feed tube, if necessary. Process to slice.

Melt margarine in large saucepan or Dutch oven over medium-high heat. Add onions. Cook and stir for 5 to 7 minutes, until onions are tender. Add flour and pepper. Stir to mix. Add broth, sherry, and Worcestershire sauce. Heat to boiling. Cook for 1 minute.

Spoon into 6 individual oven-proof soup bowls. Top with croutons and Gruyere cheese. Sprinkle with Parmesan cheese. Place under broiler for 2 to 3 minutes, until cheese is melted and bubbly.

Yield: 6 cups (6 1-cup servings).

Per serving: About 291 cal, 14 g pro, 20 g car, 15 g fat, 25 mg chol, 482 mg sod.



## WINTER ROOT SOUP WITH POTATOES

- 1/4 cup fresh parsley leaves*
- 3 tablespoons olive oil*
- 1 large leek, white part only, cut in 1-inch pieces*
- 3 parsnips, cut in 2 1/2-inch pieces*
- 2 large carrots, cut in 2 1/2-inch pieces*
- 1 rib celery, cut in 2 1/2-inch pieces*
- 1 turnip*
- 2 potatoes*
- 1/2 teaspoon ground allspice*
- 1 cup water*
- 4 cups reduced-sodium chicken broth*

Position mini bowl and mini blade in work bowl. With processor running, add parsley through feed tube. Process until finely chopped, about 10 seconds. Set aside. Heat oil in large saucepan or Dutch oven over low heat.

Exchange mini bowl and mini blade for multipurpose blade. Add leek to work bowl. Pulse 5 times, about 1 second each time, until coarsely chopped. Remove to saucepan.

Exchange multipurpose blade for reversible slicing/shredding disc to slice. Add parsnips, carrots, and celery. Add turnip, cut to fit feed tube if necessary. Process to slice. Remove to saucepan.

Increase heat to medium. Cook and stir for 4 to 6 minutes, until crisp-tender.

Exchange reversible slicing/shredding disc for 4 mm shredding disc. Add potatoes, cut to fit feed tube, if necessary. Process to shred.

Add to saucepan with allspice, water, and broth. Heat to boiling. Reduce heat to medium-low. Cover. Cook for 25 to 30 minutes, until vegetables are tender. Add 2 cups cooked vegetables to work bowl. Process until pureed, about 10 seconds. Add back to soup with parsley.

Yield: 7 cups (7 1-cup servings).

Per serving: About 158 cal, 4 g pro, 23 g car, 7 g fat, 0 mg chol, 205 mg sod.



## CALICO CORN CHOWDER

- 1 clove garlic
- 1 medium onion, cut in 1-inch pieces
- 1 rib celery, cut in 1-inch pieces
- 1 tablespoon vegetable oil
- 2 cups fresh or frozen (thawed) corn kernels
- 2 medium potatoes
- 1 medium carrot, cut in 2½-inch pieces
- 3 cups water
- 1-2 teaspoons dried marjoram
- 1 teaspoon seasoned salt
- ¼ teaspoon black pepper
- 1½ cups skim or low-fat milk
- 2 tablespoons all-purpose flour

Position multipurpose blade in work bowl. Add garlic, onion, and celery. Process to finely chop, about 5 seconds.

Heat oil in large saucepan or Dutch oven over medium-high heat, until oil sizzles. Add garlic, onion, and celery. Cook for 2 to 3 minutes, until crisp-tender.

Add corn to work bowl. Process to partially puree, about 5 seconds. Remove to saucepan, using rubber scraper, if necessary.

Exchange multipurpose blade for 4 mm shredding disc. Add potatoes, cut to fit feed tube, and carrot. Process to shred. Add to saucepan. Add water, marjoram, seasoned salt, and pepper. Heat to boiling. Reduce heat to medium-low. Cover. Cook for 15 minutes, until vegetables are tender.

In small mixing bowl, combine milk and flour. Add to saucepan. Stir to mix. Heat to boiling. Cook for 1 minute.

Yield: 7 cups (7 1-cup servings).

Per serving: About 122 cal, 4 g pro, 23 g car, 2 g fat, 1 mg chol, 345 mg sod.



## CHEESE SANDWICH SPREAD

- 1/2 red bell pepper, cut in half, seeds removed*
- 8 ounces sharp process American cheese, cut in 1-inch cubes*
- 4 ounces cream cheese, cut in 1-inch cubes*
- 1/3 cup reduced-calorie mayonnaise*
- 1 teaspoon dry mustard*
- 1 teaspoon Worcestershire sauce*
- 1/4 teaspoon cayenne pepper*

To roast red bell pepper, place halves, skin side up, 4 inches from broiler for 5 to 7 minutes, until skin is blackened and blistered. Place in plastic bag. Close tightly. Let rest for 10 minutes. Peel. Cut in 1-inch pieces. Set aside.

Position multipurpose blade in work bowl. Add all ingredients except bell pepper. Process until smooth and creamy, about 30 seconds, scraping sides of bowl after 15 seconds, if necessary. Add bell pepper. Process to chop in small pieces, about 10 to 15 seconds.

Yield: 2 $\frac{1}{4}$  cups (9  $\frac{1}{4}$ -cup servings).

Per serving: About 167 cal, 7 g pro, 2 g car, 15 g fat, 40 mg chol, 455 mg sod.

## HAM SANDWICH SPREAD

- 1/2 small onion, cut in 1-inch pieces*
- 4 ounces Monterey Jack Hot Pepper Cheese, cut in 1/2-inch cubes*
- 8 ounces (about 2 cups) cooked ham, cut in 1-inch pieces*
- 1/4 cup chili sauce*

Position multipurpose blade in work bowl. Add onion. Pulse 3 times, about 1 second each time, until coarsely chopped. Add cheese. Pulse 4 times, about 1 second each time, until coarsely chopped. Add ham. Process to finely chop all ingredients, about 10 seconds, scraping sides of bowl after 5 seconds, if necessary. Add chili sauce. Process to mix well, about 6 to 8 seconds.

Serve cold in sandwich buns or spread on English muffin halves and place under broiler for 3 to 4 minutes, until lightly browned and bubbly.

Yield: 2 cups (6  $\frac{1}{3}$ -cup servings).

Per serving: About 150 cal, 13 g pro, 3 g car, 9 g fat, 40 mg chol, 804 mg sod.





## CHUTNEY CHICKEN SPREAD

- 2 cups cooked chicken, cut in 1/2-inch pieces
- 1/2 cup jicama, cut in 1/2-inch cubes
- 1/4 cup walnuts
- 1/3 cup reduced-calorie mayonnaise
- 1/3 cup mango chutney
- 1/4 teaspoon salt
- 1/8 teaspoon black pepper

Position multipurpose blade in work bowl. Add chicken. Pulse 5 times, about 1 second each time, until coarsely chopped. Add jicama. Pulse 3 to 4 times, about 1 second each time, until coarsely chopped. Add walnuts. Pulse 3 to 4 times, about 1 second each time, until coarsely chopped. Add mayonnaise, chutney, salt, and pepper. Pulse 4 times, about 1 second each time, until finely chopped and thoroughly mixed.

Yield: 2 cups (4 1/2-cup servings).

Per serving: About 270 cal, 22 g pro, 12 g car, 15 g fat, 64 mg chol, 309 mg sod.

## BEAN AND VEGGIE MELT

- 8 ounces Monterey Jack cheese
- 1/4 small red onion
- 1 small green bell pepper, halved, seeded
- 1 firm medium tomato
- 1 clove garlic
- 1 can (15 1/2 oz.) pinto beans, well drained
- 1/2 teaspoon ground cumin
- 4 soft pita breads

Position 4 mm shredding disc in work bowl. Add cheese. Process to shred. Set aside.

Exchange shredding disc for 4 mm slicing disc. Add onion, bell pepper, and tomato, cut up to fit feed tube, if necessary. Process to slice. Set aside.

Exchange slicing disc for multipurpose blade. With processor running, add garlic through feed tube. Process until finely chopped, about 5 seconds. Add beans and cumin. Process until smooth, about 10 seconds.

Spread bean mixture evenly over pita breads. (If beans are very dry, add 1 to 2 tablespoons water to achieve good spreading consistency.) Spoon vegetables on bean mixture. Top with shredded cheese. Place on ungreased cookie sheet. Bake at 350°F for 10 to 15 minutes, until thoroughly heated and cheese is melted. Cut in half to serve.

Yield: 4 servings.

Per serving: About 501 cal, 27 g pro, 57 g car, 18 g fat, 54 mg chol, 838 mg sod.



## VEGETABLE HOAGIE

- 1 clove garlic
- 1 tablespoon fresh basil leaves or 1 teaspoon dried basil
- 1/4 cup stuffed green olives
- 1/4 cup pitted ripe olives
- 6 ounces provolone cheese
- 2 large carrots, cut in 2 1/2-inch pieces
- 2-3 tablespoons olive oil
- 1 medium zucchini, cut in 2 1/2-inch pieces
- 1/4 red onion
- 2 medium plum tomatoes
- 2 tablespoons balsamic vinegar
- 1/2 teaspoon sugar
- 4 hoagie buns, split and buttered, if desired

Position mini bowl and mini blade in work bowl. With processor running, add garlic and basil through feed tube. Process until finely chopped, about 10 seconds. Add green and ripe olives. Pulse 3 to 4 times, about 1 second each time, until coarsely chopped. Set aside.

Exchange mini bowl and mini blade for 4 mm shredding disc. Add cheese, cut up to fit feed tube, if necessary. Process to shred. Set aside. Wipe out work bowl, if necessary.

Exchange shredding disc for 4 mm slicing disc. Add carrots. Process to slice lengthwise.

Heat 1 to 2 tablespoons olive oil in large skillet over medium heat, until oil sizzles. Add carrots. Cook 5 minutes until crisp-tender, stirring occasionally. Push to edge of skillet.

Add zucchini to work bowl. Process to slice lengthwise. Add to skillet, adding oil, if necessary. Cook 1 to 2 minutes, until slightly soft. Remove skillet from heat.

Add onion and tomatoes to work bowl. Process to slice. Add to skillet. Add olive mixture, vinegar, and sugar to skillet. Stir gently. Cover. Let stand 10 minutes to marinate. Spoon mixture into hoagie buns. Top with cheese.

Yield: 4 servings.

Per serving: About 460 cal, 18 g pro, 46 g car, 23 g fat, 40 mg chol, 1102 mg sod.

A decorative graphic featuring a central fork and knife icon, flanked by stylized, symmetrical scrollwork or floral patterns. The entire graphic is rendered in a light gray color.

# VEGETABLES AND SIDE DISHES



## DILLED CUCUMBERS AND ONIONS

- 2 *medium cucumbers, peeled*
- 1 *small onion*

Position reversible slicing/shredding disc in work bowl to slice. Add cucumbers and onions. Process to slice. Remove to shallow dish.

### **Dressing**

- $\frac{1}{2}$  *cup white wine vinegar*
- $\frac{1}{4}$  *cup fresh dill weed*
- 2 *tablespoons sugar*
- $\frac{1}{4}$  *teaspoon salt*
- $\frac{1}{4}$  *teaspoon black pepper*

Exchange reversible slicing/shredding disc for mini bowl and mini blade. Add dressing ingredients. Process until dill is finely chopped, about 10 to 12 seconds, scraping sides of bowl, if necessary.

Pour dressing over cucumber and onion. Stir to coat. Cover. Refrigerate for 8 hours or overnight, stirring occasionally.

Yield: 6 servings.

Per serving: About 35 cal, 1 g pro, 9 g car, 0 g fat, 0 mg chol, 92 mg sod.

## SCALLOPED POTATOES

- 5 *medium potatoes*
- 1 *medium onion*
- 3 *tablespoons margarine or butter*
- 3 *tablespoons all-purpose flour*
- $\frac{1}{2}$  *teaspoon garlic salt*
- $\frac{1}{8}$ - $\frac{1}{4}$  *teaspoon black pepper*
- $\frac{1}{8}$ - $\frac{1}{4}$  *teaspoon red pepper*
- 2 $\frac{1}{4}$  *cups skim or low-fat milk*

Spray 12 x 8 x 2-inch baking dish with no-stick cooking spray.

Position 4 mm slicing disc in work bowl. Add potatoes and onion. Cut to fit feed tube if necessary. Process to slice. Place in baking dish.

Melt margarine in 2-quart saucepan over medium heat. Stir in flour, salt, and pepper. Cook until mixture is smooth and bubbly, stirring constantly. Add milk. Heat to boiling, stirring constantly. Cook and stir for 1 minute.

Pour mixture over potatoes and onion. Cover dish with foil. Bake at 350°F for 45 minutes. Remove foil. Bake for 30 minutes more, until tender.

Yield: 6 servings.

Per serving: About 192 cal, 6 g pro, 30 g car, 6 g fat, 2 mg chol, 297 mg sod.



## SAUTÉED ZUCCHINI AND PEPPERS

- 3 *medium zucchini, cut in 2½-inch pieces*
- 2 *medium bell peppers, red and/or yellow, cut in quarters*
- 2 *tablespoons margarine or butter*
- ¾ *teaspoon dried dill weed*
- 1 *clove garlic, minced*
- ⅛-¼ *teaspoon salt*
- ⅛-¼ *teaspoon black pepper*

Position 4 mm slicing disc in work bowl. Add zucchini and bell peppers. Process to slice.

Melt margarine in large skillet over medium-high heat. Stir in dill weed, garlic, salt, and pepper. Add zucchini and bell peppers. Stir to coat vegetables with seasonings. Cover. Cook for 4 to 6 minutes, until vegetables are crisp-tender.

Yield: 6 servings.

Per serving: About 55 cal, 1 g pro, 5 g car, 4 g fat, 0 mg chol, 137 mg sod.

## SHREDDED VEGETABLE SAUTÉ

- 1 *medium sweet potato*
- 1 *small (about 8 oz.) jicama*
- 1 *small zucchini, cut in 2½-inch pieces*
- 2 *tablespoons margarine or butter*
- 3 *tablespoons fresh lemon juice*
- 1 *tablespoon toasted sesame seed*
- ½ *teaspoon salt*
- ¼ *teaspoon black pepper*

Position 4 mm shredding disc in work bowl. Add sweet potato, jicama, and zucchini. Cut to fit feed tube if necessary. Process to shred.

Melt margarine in large skillet over medium-high heat. Add vegetables. Cook and stir for 5 minutes, until vegetables are crisp-tender. Add remaining ingredients. Cook and stir for 1 minute.

Yield: 6 servings.

Per serving: About 91 cal, 2 g pro, 11 g car, 5 g fat, 0 mg chol, 230 mg sod.



## CABBAGE, ONION AND NOODLE CASSEROLE

---

- 1/2 medium (about 3/4 lb.) green cabbage*
- 2 ounces Cheddar cheese*
- 1 medium onion, cut in 4 pieces*
- 1/4 cup loosely packed parsley leaves*
- 1 tablespoon margarine or butter*
- 1/4 cup water*
- 2 cups cooked noodles*
- 1 can (10 3/4 oz.) low-sodium cream of mushroom soup*
- 3/4 cup skim or low-fat milk*
- 1 jar (2 oz.) diced pimientos*
- 1/2 teaspoon black pepper*

Spray 8 x 8 x 2-inch baking dish with no-stick cooking spray.

Position reversible slicing/shredding disc in work bowl to slice. Add cabbage. Cut to fit feed tube if necessary. Process to slice. Set aside. Reverse disc. Add cheese. Process to shred. Set aside.

Exchange reversible slicing/shredding disc for multipurpose blade. Add onion and parsley. Pulse 8 to 10 times, about 1 second each time, until coarsely chopped.

Melt margarine in large skillet over medium-high heat. Add onion and parsley. Cook and stir for 3 to 4 minutes, until onion is tender. Add cabbage and water. Cover. Cook for 5 minutes, until cabbage is tender.

In large mixing bowl, combine all ingredients, except cheese. Pour mixture into baking dish. Sprinkle with cheese. Bake at 350°F for 25 to 30 minutes, until bubbly around edges.

Yield: 6 servings.

Per serving: About 175 cal, 8 g pro, 26 g car, 6 g fat, 29 mg chol, 282 mg sod.

## SHREDDED BEETS

---

- 4 medium beets, cooked, peeled*
- 1/3 cup no-fat sour cream*
- 4 teaspoons prepared horseradish*
- 1 teaspoon sugar*
- 1 teaspoon vinegar*
- 1/8 teaspoon black pepper*

Position 4 mm shredding disc in work bowl. Add beets. Cut to fit feed tube if necessary. Process to shred. Remove to serving bowl.

In small bowl, combine sour cream, horseradish, sugar, vinegar, and pepper. Pour over beets.

Yield: 4 servings.

Per serving: About 40 cal, 1 g pro, 8 g car, 0 g fat, 0 mg chol, 70 mg sod.



## HONEY-GLAZED CARROTS

- 1 pound carrots, cut in 2½-inch pieces
- ¼ cup water
- ¼ teaspoon salt
- 2 tablespoons honey
- 1 tablespoon margarine or butter
- Cinnamon, if desired

Position reversible slicing/shredding disc in work bowl to slice. Add carrots. Process to slice.

In small saucepan, combine water and salt. Heat to boiling. Reduce heat to medium. Add carrots. Cook for 7 to 10 minutes, until tender. Drain.

Add honey and margarine. Stir to coat. Sprinkle with cinnamon, if desired.

Yield: 8 servings.

Per serving: About 53 cal, 1 g pro, 10 g car, 2 g fat, 0 mg chol, 103 mg sod.

## ZUCCHINI PATTIES

- 3 small zucchini, cut in 2½-inch pieces
- ½ teaspoon salt
- 1 small onion, cut in 4 pieces
- ½ small red bell pepper, cut in 2 pieces
- 2 tablespoons loosely packed parsley leaves
- ½ cup all-purpose flour
- ¼ cup fat-free egg substitute or 1 egg, beaten
- ¼ teaspoon salt
- ¼ teaspoon black pepper
- ¼ cup vegetable oil
- ¼ cup no-fat sour cream

Position reversible slicing/shredding disc in work bowl to shred. Add zucchini. Process to shred. Remove to colander. Sprinkle with salt. Let drain for 15 minutes. Squeeze dry.

Exchange reversible slicing/shredding disc for multipurpose blade. Add onion, bell pepper, and parsley. Pulse 8 to 10 times, about 1 second each time, until finely chopped.

In medium mixing bowl, combine zucchini, onion mixture, flour, egg substitute, salt, and pepper.

Heat oil in large skillet over medium-high heat, until oil sizzles. Add zucchini mixture by heaping spoonfuls; flatten. Cook for 6 to 8 minutes, until golden brown, turning once. Drain. Top with sour cream.

Yield: 8 patties (2 patties per serving).

Per serving: About 216 cal, 5 g pro, 19 g car, 14 g fat, 0 mg chol, 449 mg sod.



## RICE PILAF WITH VEGETABLES

- 1 *medium carrot, cut in 4 pieces*
- 1 *rib celery, cut in 4 pieces*
- 1 *small onion, cut in 4 pieces*
- $\frac{1}{3}$  *cup loosely packed parsley leaves*
- 2 *tablespoons margarine or butter*
- 1 *cup uncooked white rice*
- 1 *can (14½ oz.) vegetable broth*
- $\frac{1}{4}$ - $\frac{1}{2}$  *teaspoon black pepper*
- $\frac{1}{2}$  *cup freshly grated Parmesan cheese (see TIPS)*

Position multipurpose blade in work bowl. Add carrot, celery, onion, and parsley. Pulse 10 to 12 times, about 1 second each time, until vegetables are finely chopped.

Melt margarine in large skillet over medium-high heat. Add rice. Cook and stir for 5 minutes, until rice is golden brown. Add broth, vegetables, and pepper. Bring to a boil. Reduce heat to low. Cover. Cook for 15 to 20 minutes, until rice is tender. Stir rice with a fork. Pour into serving dish. Sprinkle with Parmesan cheese.

Yield: 6 servings.

Per serving: About 197 cal, 6 g pro, 30 g car, 6 g fat, 4 mg chol, 453 mg sod.





## LAYERED EGGPLANT CASSEROLE

- 1 *medium (about 1¼ to 1½ lb.) eggplant, peeled*
- 3 *ounces mozzarella cheese*
- ¼ *cup loosely packed parsley leaves*
- 1 *cup no-fat ricotta cheese*
- ½ *cup freshly grated Parmesan cheese (see TIPS)*
- 1 *egg white, slightly beaten*
- ¼ *teaspoon black pepper*
- 2 *cups spaghetti sauce*

Spray 12 x 8 x 2-inch baking dish with no-stick cooking spray.

Position reversible slicing/shredding disc in work bowl to slice. Add eggplant. Cut to fit feed tube. Process to slice. Set aside. Reverse disc. Shred mozzarella cheese. Set aside.

Exchange reversible slicing/shredding disc for mini bowl and mini blade. With processor running, add parsley through feed tube. Process until finely chopped, about 8 to 10 seconds.

In small mixing bowl, combine ricotta cheese, Parmesan cheese, egg white, parsley, and pepper.

Pour half of spaghetti sauce into baking dish. Cover with half of eggplant. Spread with ricotta cheese mixture. Cover with remaining eggplant. Cover with remaining sauce. Sprinkle with mozzarella cheese. Bake at 350°F for 35 to 45 minutes, until eggplant is tender.

Yield: 8 servings.

Per serving: About 132 cal, 10 g pro, 12 g car, 5 g fat, 21 mg chol, 191 mg sod.

A decorative graphic featuring a central fork and knife icon, flanked by symmetrical, flowing scrollwork elements. The text "MAIN DISHES" is overlaid in red on the central part of the graphic.

# MAIN DISHES



## ONION-CHEESE PIE

- 1* pastry crust (pg.89)  
*2* cloves garlic  
*2* large yellow onions, quartered lengthwise  
*1* small carrot  
*3* tablespoons margarine or butter  
*2* tablespoons all-purpose flour  
*1/2* teaspoon dried thyme  
*1/2* teaspoon salt  
*1/4* teaspoon black pepper  
*8* ounces reduced-fat or regular Swiss or Gruyere cheese
- Prepare (but do not bake) pastry crust as directed in recipe. Fit into 9-inch pie plate. Set aside.
- Position multipurpose blade in work bowl. With processor running, add garlic through feed tube. Process until chopped, about 5 to 10 seconds.
- Exchange multipurpose blade for 4 mm slicing disc. Add onions. Process to slice.
- Exchange slicing disc for reversible slicing/shredding disc to shred. Add carrot. Process to shred.
- Melt margarine in large skillet over medium heat. Add garlic, onion, and carrot. Cook for 8 to 10 minutes, until tender. Add flour, thyme, salt, and pepper. Stir to coat. Set aside.
- Exchange reversible slicing/shredding disc for 4 mm shredding disc. Add cheese. Process to shred. Add to onion mixture. Stir to mix.
- Pour into prepared pie shell. Bake at 375°F for 30 to 40 minutes, until crust is golden brown and filling is set.
- Yield: 6 servings.
- Per serving (filling and crust): About 514 cal, 17 g pro, 41 g car, 33 g fat, 12 mg chol, 518 mg sod.



## BEEF FAJITAS

- 1 medium jalapeno pepper, seeds and stem removed
- 2 cloves garlic
- 1 medium red bell pepper, seeded, halved lengthwise
- 1 medium green pepper, seeded, halved lengthwise
- 2 medium onions, halved lengthwise
- ¼ cup water
- 2 tablespoons reduced-sodium soy sauce
- 1 tablespoon brown sugar
- 2 teaspoons cornstarch
- 1 teaspoon chili powder
- ½ teaspoon cumin
- 3 teaspoons olive oil
- 1 pound beef flank steak, sliced across the grain (see TIPS)
- 6 (7 to 9-inch) flour tortillas, heated according to package

Position multipurpose blade in work bowl. With processor running, add jalapeno and garlic through feed tube. Process until chopped, about 5 to 10 seconds.

Exchange multipurpose blade for 4 mm slicing disc. Add bell peppers and onions. Process to slice.

In small bowl, combine water, soy sauce, brown sugar, cornstarch, chili powder, and cumin. Set aside.

Heat 1 teaspoon oil in large skillet or wok over medium-high heat, until oil sizzles. Add beef. Cook and stir for 5 to 8 minutes, until no longer pink. Set aside.

Add remaining 2 teaspoons oil to skillet. Add onion mixture. Cook and stir for 5 to 7 minutes, until crisp-tender. Add beef and soy sauce mixture. Cook and stir until beef and vegetables are coated and mixture is thoroughly heated.

Serve in flour tortillas with sour cream, guacamole, and salsa, if desired.

Yield: 6 servings.

Per serving: About 305 cal, 21 g pro, 33 g car, 11 g fat, 46 mg chol, 406 mg sod.



## TARRAGON CHICKEN PATTIES

- 1/3 cup skim or low-fat milk*
- 1 tablespoon all-purpose flour*
- 1/2 teaspoon dried tarragon*
- 1/4 teaspoon salt*
- 1/8 teaspoon black pepper*
- 1 teaspoon lemon juice*
- 1/4 cup fat-free egg substitute or 1 egg, beaten*
- 1 1/2 cups cubed cooked chicken or turkey breast meat*
- 1 rib celery, cut in 1-inch pieces*
- 2 green onions, cut in 1-inch pieces*
- 1 cup cooked rice*
- 1/4 cup plain dry bread crumbs*
- 2 teaspoons vegetable oil*
- Lemon juice, if desired*

In small saucepan, combine milk, flour, tarragon, salt, and pepper. Cook and stir over medium heat until thickened and bubbly. Remove from heat. Add lemon juice. Stir to mix. Add small amount of hot mixture to egg substitute. Pour all of egg mixture into hot mixture. Cook and stir for 1 minute. Set aside.

Position multipurpose blade in work bowl. Add chicken, celery, and green onions. Pulse 2 to 3 times, about 2 to 3 seconds each time, until chopped. Add hot mixture and rice. Pulse 3 to 4 times, about 2 to 3 seconds each time, until mixed. Shape into 6 patties, 1/2-inch thick. Coat both sides with bread crumbs.

Heat oil in large skillet over medium-high heat, until oil sizzles. Add patties. Cook for 5 to 6 minutes per side until thoroughly cooked, turning once. Drizzle with lemon juice, if desired.

Yield: 6 servings.

Per serving: About 155 cal, 13 g pro, 15 g car, 4 g fat, 30 mg chol, 311 mg sod.



## SZECHWAN PORK

- 3 cloves garlic
- 1 piece (1½-inch long, 1-inch in diameter) fresh ginger root, peeled
- <sup>3</sup>/<sub>4</sub> pound pork tenderloin, trimmed and sliced (see TIPS)
- 2 tablespoons reduced-sodium soy sauce, divided
- <sup>3</sup>/<sub>4</sub> teaspoon crushed red pepper flakes, divided
- 1 medium red or green bell pepper, seeded, halved lengthwise
- 2 large ribs celery, cut in 2-inch pieces
- <sup>1</sup>/<sub>2</sub> cup reduced-sodium chicken broth
- 2 teaspoons oyster sauce
- 1 teaspoon cornstarch
- 1 tablespoon peanut oil, divided
- 4 green onions, cut in 1-inch pieces  
Hot cooked rice or Chinese noodles, if desired

Position multipurpose blade in work bowl. With processor running, add garlic and ginger root through feed tube. Process until chopped, about 10 to 15 seconds.

In medium bowl, combine pork, garlic mixture, 1 tablespoon soy sauce, and <sup>1</sup>/<sub>2</sub> teaspoon red pepper flakes. Toss to coat. Marinate in refrigerator 1 to 2 hours.

Exchange multipurpose blade for 4 mm slicing disc. Add bell pepper. Process to slice. Place celery crosswise in feed tube. Process to slice.

In small bowl, combine broth, remaining 1 tablespoon soy sauce, oyster sauce, cornstarch, and remaining <sup>1</sup>/<sub>4</sub> teaspoon red pepper flakes. Set aside.

Heat 1 teaspoon oil in large skillet or wok over medium-high heat, until oil sizzles. Add pork mixture. Cook and stir for 5 to 8 minutes, until pork is thoroughly cooked. Set aside.

Heat remaining 2 teaspoons oil. Add bell pepper and celery. Cook and stir for 3 to 4 minutes, until crisp-tender. Add onion. Cook and stir for 1 minute. Add pork and broth mixture. Cook and stir until thickened and bubbly. Serve over hot cooked rice or Chinese noodles, if desired.

Yield: 4 servings.

Per serving: About 204 cal, 26 g pro, 6 g car, 8 g fat, 79 mg chol, 539 mg sod.



## CHICKEN AND BROCCOLI STIR-FRY

- 2 *cloves garlic*
- 1 *egg white*
- 1 *tablespoon cornstarch, divided*
- 1 *tablespoon plus 1 teaspoon reduced-sodium soy sauce, divided*
- $\frac{1}{2}$  *teaspoon sesame oil*
- $\frac{1}{4}$  *teaspoon crushed red pepper flakes*
- $\frac{1}{8}$  *teaspoon ginger*
- 2 *whole boneless, skinless chicken breasts, sliced (see TIPS)*
- $\frac{3}{4}$  *cup reduced-sodium chicken broth*
- 1 *cup fresh mushrooms*
- 1 *medium onion, halved lengthwise*
- $\frac{1}{2}$  *medium head (about 8 oz.) broccoli*
- 1 *medium carrot*
- 4 *teaspoons peanut oil*
- Hot cooked rice, if desired*

Position mini bowl and mini blade in work bowl. With processor running, add garlic through feed tube. Process until chopped, about 5 to 10 seconds. Add egg white, 1 teaspoon cornstarch, 1 teaspoon soy sauce, sesame oil, red pepper flakes, and ginger. Process until mixed, about 5 to 10 seconds.

Combine chicken with egg white mixture in medium mixing bowl. Toss to coat. Marinate 1 to 2 hours in refrigerator.

In small bowl, combine broth, remaining 1 tablespoon soy sauce, and remaining 2 teaspoons cornstarch. Set aside.

Exchange mini bowl and mini blade for 4 mm slicing disc. Add mushrooms and onion. Process to slice.

Cut florets from broccoli stem. Cut florets into small pieces. Set aside. Add broccoli stalk to work bowl. Process to slice.

Exchange slicing disc for 4 mm shredding disc. Add carrot. Process to shred.

In large skillet or wok over medium-high heat, heat 2 teaspoons peanut oil, until oil sizzles. Add chicken mixture. Cook and stir for 5 to 8 minutes, until no longer pink. Set aside.

Heat remaining 2 teaspoons oil. Add vegetables, including broccoli florets. Cook and stir for 7 to 9 minutes, until crisp-tender. Add chicken and broth mixture to vegetables. Cook and stir until thickened. Serve over hot cooked rice, if desired.

Yield: 6 cups (6 1-cup servings).

Per serving: About 163 cal, 20 g pro, 7 g car, 6 g fat, 44 mg chol, 387 mg sod.



## TURKEY SLICES WITH FRESH ITALIAN TOMATO SAUCE

- 1/3 cup loosely packed fresh basil leaves*
- 1/4 cup loosely packed fresh parsley*
- 3 cloves garlic*
- 1 medium onion, halved lengthwise*
- 4 teaspoons olive oil, divided*
- 2 firm ripe medium tomatoes, cored, cut in 8 pieces each*
- 1/2 teaspoon brown sugar*
- 1/2 teaspoon salt*
- 1/8-1/4 teaspoon crushed red pepper flakes*
- 1 tablespoon tomato paste, if desired*
- 1 pound turkey breast slices*
- 1/2-1 teaspoon seasoned salt*
- 1/4 teaspoon black pepper*
- 2 teaspoons margarine or butter*

Position multipurpose blade in work bowl. With processor running, add basil and parsley through feed tube. Process until chopped, about 5 to 10 seconds. Set aside. With processor running, add garlic through feed tube. Process until chopped, about 5 to 10 seconds.

Exchange multipurpose blade for 4 mm slicing disc. Add onion. Process to slice.

Heat 2 teaspoons oil in skillet over medium heat, until oil sizzles. Add onion and garlic. Cook and stir for 3 minutes, until onion is crisp-tender. Remove from heat.

Exchange slicing disc for multipurpose blade. Add tomatoes. Pulse 1 to 2 times, about 2 to 3 seconds each time, until coarsely chopped.

Add tomatoes, brown sugar, salt, and red pepper flakes to onion mixture. Cook over medium-high heat until bubbly. Add basil mixture.

Reduce heat. Cook for 5 to 10 minutes, until flavors are blended. Add tomato paste for thicker sauce, if desired. Pour into serving container. Keep warm. Wipe skillet clean.

Sprinkle turkey slices lightly with seasoned salt and pepper. Heat remaining two teaspoons oil and margarine in skillet over medium heat, until oil sizzles. Add turkey slices. Cook for 5 to 10 minutes, until thoroughly cooked, turning once. Serve turkey topped with tomato sauce.

Yield: 6 servings.

Per serving: About 161 cal, 19 g pro, 6 g car, 7 g fat, 45 mg chol, 376 mg sod.





## VEGETABLE EGG FOO YUNG

- 1 *small carrot, cut in 4 pieces*
- 2 *green onions, cut in 1-inch pieces*
- 1 *cup fresh mushrooms*
- 1 *small onion*
- 5 *teaspoons peanut oil, divided*
- 1½ *cups fat-free egg substitute or 6 eggs*
- ½ *teaspoon salt*
- ⅛ *teaspoon black pepper*
- 2 *cups (8 oz.) fresh bean sprouts*
- 1 *cup reduced-sodium chicken broth*
- 2 *tablespoons reduced-sodium soy sauce*
- 1 *tablespoon cornstarch*
- Dash white pepper*

Position multipurpose blade in work bowl. Add carrot. Pulse 1 to 2 times, about 2 to 3 seconds each time, until coarsely chopped. Add green onion. Pulse 1 to 2 times, about 2 to 3 seconds each time, until finely chopped.

Exchange multipurpose blade for 4 mm slicing disc. Add mushrooms and onion. Process to slice.

Heat 2 teaspoons oil in large skillet over medium heat, until oil sizzles. Add vegetable mixture. Cook and stir for 3 to 4 minutes, until vegetables are tender. Remove from heat.

In medium bowl, combine egg substitute, salt, and black pepper. Add vegetable mixture and bean sprouts. Stir to mix.

Heat about 1 teaspoon oil in same skillet over medium heat. Pour about ⅓ cup egg-vegetable mixture into skillet for each of 3 patties. Fry patties for 4 to 6 minutes, until set and golden brown, turning once. While patties are cooking, gently push egg mixture back up over vegetables. Remove patties from skillet. Keep warm. Repeat with remaining oil and egg-vegetable mixture. Remove skillet from heat.

In same skillet, combine broth, soy sauce, cornstarch, and white pepper. Cook and stir over medium heat until thickened and bubbly. Reduce heat to medium-low. Add patties to sauce. Spoon sauce over patties. Heat thoroughly.

Yield: 8 servings.

Per serving: About 93 cal, 7 g pro, 6 g car, 5 g fat, 0 mg chol, 415 mg sod.



## SPICY CHICKEN LO MEIN

- 2 cloves garlic
- 1 piece (1½ inch long, 1 inch in diameter) fresh ginger root, peeled
- 1 egg white
- 2 tablespoons plus 2 teaspoons reduced-sodium soy sauce, divided
- 1 tablespoon cornstarch, divided
- ½ teaspoon sesame oil
- ¼-½ teaspoon crushed red pepper flakes
- 1 whole boneless, skinless chicken breast, cut in ½-inch strips (see TIPS)
- 1 rib celery, cut in 4 pieces
- 1 cup fresh mushrooms
- ¾ cup reduced-sodium chicken broth
- 4 teaspoons peanut oil
- 3 green onions, cut in 1-inch pieces
- 1 cup (4 oz.) fresh pea pods, trimmed, halved
- 1 cup (4 oz.) fresh bean sprouts
- 6 ounces curly Chinese noodles or vermicelli pasta, cooked and drained

Position mini bowl and mini blade in work bowl. With processor running, add garlic and ginger root through feed tube. Process until chopped, about 15 to 20 seconds. Add egg white, 2 teaspoons soy sauce, 1 teaspoon cornstarch, sesame oil, and red pepper flakes. Process until mixed, about 5 to 10 seconds.

In medium bowl, combine chicken and egg white mixture. Toss to coat. Set aside.

Exchange mini bowl and mini blade for 4 mm slicing disc. Add celery. Process to slice. Set aside. Add mushrooms to work bowl. Process to slice.

In small bowl, combine broth, remaining 2 tablespoons soy sauce, and remaining 2 teaspoons cornstarch. Set aside.

Heat 2 teaspoons oil in Dutch oven or wok over medium-high heat, until oil sizzles. Add chicken mixture. Cook and stir for 5 to 8 minutes, until chicken is no longer pink. Set aside.

Heat remaining 2 teaspoons oil in same skillet. Add celery. Cook and stir for 1 minute. Add mushrooms, green onions, pea pods, and bean sprouts. Cook and stir for 2 to 3 minutes, until vegetables are crisp-tender. Add chicken mixture and broth mixture. Cook and stir until thickened and bubbly. Add noodles or pasta. Toss to coat. Heat thoroughly.

Yield: 4 to 6 servings.

Per serving: About 298 cal, 20 g pro, 36 g car, 8 g fat, 33 mg chol, 336 mg sod.



## BEEF CHOW MEIN

- 1 clove garlic
- 2 teaspoons reduced-sodium soy sauce
- 1 tablespoon plus 1 teaspoon peanut oil, divided
- 1 tablespoon cornstarch, divided
- ¼ teaspoon ginger
- Dash black pepper
- 1 pound boneless beef sirloin, trimmed, sliced (see TIPS)
- ⅔ cup reduced-sodium chicken broth
- 1 tablespoon oyster sauce
- 2 cups fresh mushrooms
- 1 rib celery, cut in 2½-inch pieces
- 3 green onions, cut in 1-inch pieces
- 1 can (8 oz.) bamboo shoots, drained
- 1 can (8 oz.) sliced water chestnuts, drained
- Hot cooked rice or chow mein noodles, if desired

Position mini bowl and mini blade in work bowl. With processor running, add garlic through feed tube. Process until chopped, about 10 to 15 seconds. Add soy sauce, 1 teaspoon oil, 1 teaspoon cornstarch, ginger, and pepper. Process until blended, about 5 to 10 seconds.

In medium bowl, combine soy sauce mixture and beef. Toss to coat. Marinate 1 to 2 hours in refrigerator.

In small bowl, blend broth, oyster sauce, and remaining 2 teaspoons cornstarch. Set aside.

Exchange mini bowl and mini blade for 4 mm slicing disc. Add mushrooms and celery. Process to slice.

Heat 1 teaspoon oil in large non-stick skillet or wok over medium-high heat, until oil sizzles. Add beef mixture. Cook and stir for 5 to 8 minutes, until beef is thoroughly cooked. Set aside.

Heat remaining 2 teaspoons oil in same skillet. Add mushrooms and celery. Cook and stir for 3 to 4 minutes, until celery is crisp-tender. Add green onions, bamboo shoots, and water chestnuts. Stir-fry for 1 minute. Add beef and broth mixture. Cook and stir until thickened and bubbly. Serve over hot cooked rice or chow mien noodles, if desired.

Yield: 4 to 6 servings.

Per serving: About 246 cal, 32 g pro, 16 g car, 6 g fat, 75 mg chol, 415 mg sod.



## SHRIMP AND SCALLOP SAUTÉ WITH PASTA AND VEGETABLES

- 2 cloves garlic
- 1 medium onion,  
halved lengthwise
- 1½ cups fresh  
mushrooms
- 1 small carrot
- 2 cups loosely packed  
spinach leaves,  
washed and dried
- 1 cup reduced-sodium  
chicken broth
- 2 teaspoons  
cornstarch
- ¼ teaspoon crushed  
red pepper flakes
- 1 tablespoon  
peanut oil
- 1½ teaspoons  
sesame oil
- 8 ounces shelled,  
deveined raw  
shrimp, thawed
- 8 ounces bay scallops,  
thawed
- 1 cup brine-packed  
baby corn on the  
cob, drained
- 8 ounces vermicelli  
pasta, cooked  
and drained

Position multipurpose blade in work bowl. With processor running, add garlic through feed tube. Process until chopped, about 5 to 10 seconds.

Exchange multipurpose blade for reversible slicing/shredding disc to slice. Add onion. Process to slice. Set aside. Add mushrooms. Process to slice.

Reverse slicing/shredding disc to shred. Add carrot. Process to shred. Set aside mushrooms and carrot.

Exchange reversible slicing/shredding disc for 4 mm slicing disc. Lay spinach leaves flat and stack together. Roll up entire stack into bundle to fit feed tube. Place in feed tube and slice.

In small bowl, blend broth, cornstarch, and red pepper flakes.

Heat peanut oil and sesame oil in large non-stick saucepan or wok over medium-high heat, until oil sizzles. Add onion mixture, shrimp, and scallops. Cook and stir for 2 minutes. Add mushrooms, carrot, and corn. Cook and stir for 2 to 3 minutes, until mixture is hot and shrimp and scallops are opaque. Add broth mixture. Cook and stir until bubbly and thickened. Add spinach. Toss to mix. Add hot cooked vermicelli. Toss to mix.

Yield: 4 to 6 servings.

Per serving: About 470 cal, 36 g pro, 63 g car, 9 g fat, 129 mg chol, 680 mg sod.



## VEGETARIAN PIZZA

- 1 recipe white bread dough (pg. 76)
- 8 ounces part-skim mozzarella or provolone cheese
- 2 cloves garlic
- 1 medium onion, halved lengthwise
- 1 tablespoon olive oil
- 1 medium green bell pepper, seeded, halved lengthwise
- 1 cup fresh mushrooms
- 1 small zucchini or yellow summer squash
- 3 firm ripe medium tomatoes, cored, cut in 8 pieces each
- 1 teaspoon oregano leaves
- ½ teaspoon salt
- 6-8 drops hot pepper sauce
- Cornmeal
- 2 tablespoons freshly grated Parmesan cheese (see TIPS)
- Prepare bread dough and let rise once, as directed in recipe.
- Position 4 mm shredding disc in work bowl. Add cheese. Process to shred. Set aside.
- Exchange shredding disc for multipurpose blade. With processor running, add garlic through feed tube. Process until chopped, about 5 to 10 seconds.
- Exchange multipurpose blade for reversible slicing/shredding disc to slice. Add onion. Process to slice. Set aside.
- Heat oil in large non-stick skillet over medium heat, until oil sizzles. Add garlic and onion. Cook for 5 minutes, until onion is tender.
- Add green pepper, mushrooms, and zucchini to work bowl. Process to slice. Set aside.
- Exchange reversible slicing/shredding disc for multipurpose blade. Add tomatoes. Pulse 1 to 2 times, about 1 to 2 seconds each time, until chopped. Add tomatoes, oregano, salt, and hot pepper sauce to onion mixture. Cook for 10 to 15 minutes, until mixture is thickened and most liquid is evaporated, stirring occasionally. Remove from heat.
- Lightly grease pizza pan or large baking sheet. Sprinkle with cornmeal. Press dough to a 12-inch circle. Spread tomato mixture on crust. Top with vegetables. Bake at 425°F for 10 minutes. Top with mozzarella and Parmesan cheeses. Bake for 8 to 12 minutes more, until crust is golden brown and cheese is melted.

Yield: 8 servings.

Per serving: About 355 cal, 16 g pro, 49 g car, 11 g fat, 17 mg chol, 627 mg sod.



## VEGETABLE-STUFFED CHICKEN BREASTS

- 4 *boneless, skinless chicken breast halves*
- 2 *cloves garlic*
- $\frac{1}{2}$  *medium (about 8 oz.) head broccoli*
- 2 *medium shallots, halved*
- 1 *medium carrot*
- 1 *tablespoon olive oil*
- 1 *tablespoon margarine or butter*
- 1 *slice bread, torn in 4 pieces*
- $\frac{1}{4}$  *cup toasted pine nuts\**
- $\frac{1}{2}$  *teaspoon dried marjoram*
- $\frac{1}{2}$  *teaspoon salt*
- $\frac{1}{4}$  *teaspoon black pepper*

Place chicken breast halves between 2 sheets of plastic wrap. Using meat mallet or rolling pin, flatten chicken breasts to  $\frac{1}{4}$  to  $\frac{1}{2}$ -inch thickness. Set aside.

Position multipurpose blade in work bowl. With processor running, add garlic through feed tube. Process until chopped, about 5 to 10 seconds. Cut broccoli florets from stem. Add florets and shallots to work bowl. Pulse 3 to 4 times, about 1 to 2 seconds each time, until chopped.

Exchange multipurpose blade for reversible slicing/shredding disc. Shred broccoli stem and carrot.

Heat oil and margarine in medium non-stick skillet over medium heat, until oil sizzles. Add vegetable mixture. Cook and stir about 5 minutes, until vegetables are tender. Set aside.

Exchange reversible slicing/shredding disc for multipurpose blade. Add bread. Process until fine, about 5 to 10 seconds. Add bread crumbs, pine nuts, marjoram, salt, and pepper to vegetable mixture.

Spread one-fourth of vegetable mixture over each flattened chicken breast half. Roll up jelly-roll style. Secure with wooden picks, if desired. Spray 9 x 9 x 2-inch baking pan with no-stick cooking spray. Arrange chicken rolls seam side down in pan. Bake at 375°F for 25 to 35 minutes, until thoroughly cooked and juices run clear.

Yield: 4 servings.

\* To toast pine nuts, spread in single layer in shallow baking dish. Bake at 375°F for 5 to 7 minutes, until golden, stirring occasionally.

Per serving: About 391 cal, 40 g pro, 10 g car, 22 g fat, 93 mg chol, 508 mg sod.



## CHICKEN-VEGETABLE FRITTATA

- 1 medium shallot
- 1 whole boneless, skinless chicken breast, sliced (see TIPS)
- 1 cup fresh mushrooms
- 1 small zucchini
- <sup>3</sup>/<sub>4</sub> cup fat-free egg substitute or 3 eggs
- 2 teaspoons skim milk
- <sup>1</sup>/<sub>4</sub> teaspoon salt
- Dash black pepper
- 2 ounces reduced-fat colby cheese

Position multipurpose blade in work bowl. With processor running, add shallot through feed tube. Process until chopped, about 5 to 10 seconds.

Spray 12-inch skillet with no-stick cooking spray. Heat over medium-high heat. Add shallot and chicken. Cook and stir for 5 to 8 minutes, until chicken is no longer pink. Set aside.

Exchange multipurpose blade for reversible slicing/shredding disc to slice. Add mushrooms. Process to slice.

Reverse disc to shred. Add zucchini. Process to shred. Combine mixture with chicken in skillet. Cook and stir over medium-high heat for 2 minutes, until crisp-tender.

In small bowl, combine egg substitute, milk, salt, and pepper. Pour evenly over vegetables in skillet. Reduce heat to medium. Cover. Cook for 3 to 5 minutes, just until set, occasionally lifting edges of egg mixture to allow uncooked egg to flow to the outer edge.

Add cheese to work bowl. Process to shred. Sprinkle over egg mixture. Cover. Reduce heat to low. Cook for 1 to 2 minutes to melt cheese.

Yield: 4 to 6 servings.

Per serving: About 149 cal, 22 g pro, 5 g car, 4 g fat, 41 mg chol, 333 mg sod.



## SATAY CHICKEN STRIPS WITH PEANUT SAUCE

- 2 *cloves garlic*
- $\frac{1}{4}$  *cup reduced-sodium soy sauce*
- 2 *tablespoons peanut oil, divided*
- 1 *teaspoon brown sugar*
- $\frac{1}{4}$  *teaspoon ginger*
- 3 *boneless, skinless chicken breast halves, cut in  $\frac{1}{2}$ -inch strips (see TIPS)*
- $\frac{1}{4}$  *cup loosely packed cilantro leaves*
- 1 *small onion, quartered*
- $\frac{1}{3}$  *cup peanut butter*
- $\frac{1}{3}$  *cup water*
- 1 *tablespoon lemon juice*
- $\frac{1}{8}$ - $\frac{1}{4}$  *teaspoon crushed red pepper flakes*

Position mini bowl and mini blade in work bowl. With processor running, add garlic through feed tube. Process until chopped, about 5 to 10 seconds. Add soy sauce, 1 tablespoon oil, brown sugar, and ginger. Pulse 2 to 3 times, about 1 to 2 seconds each time, until blended.

In medium bowl, combine chicken strips and soy sauce mixture. Toss to coat. Marinate  $\frac{1}{2}$  hour at room temperature or at least 2 hours in refrigerator. Remove chicken from marinade, retaining marinade.

Thread chicken strips on 4 oiled metal or soaked wooden 10-inch skewers. Place on foil-lined baking sheet. Broil 4 to 6 inches from heat for 5 to 8 minutes, until thoroughly cooked, turning once. Brush with any remaining marinade once during cooking, if desired.

With processor running, add cilantro through feed tube. Process until chopped, about 5 to 10 seconds. Set aside. Add onion to mini bowl. Pulse 2 to 3 times, about 3 to 4 seconds each time, until chopped.

Heat remaining 1 tablespoon oil in small saucepan over medium heat, until oil sizzles. Add onion. Cook and stir for 3 minutes, until tender. Reduce heat to low. Add peanut butter, water, lemon juice, red pepper flakes, and cilantro. Cook and stir until mixed. Serve with skewered chicken.

Yield: 4 main dish or 8 appetizer servings.

Per main dish serving: About 316 cal, 26 g pro, 9 g car, 20 g fat, 50 mg chol, 750 mg sod.





## HAM LOAF

- 2 slices bread, torn in 4 pieces each
- 1 pound (about 2½ cups) extra lean or regular ham, cut in 1½-inch cubes
- 1 medium onion, quartered
- ¼ medium green bell pepper, seeded, quartered
- 1 small carrot, cut in 3 pieces
- ½ pound lean ground turkey meat, crumbled
- ½ cup fat-free egg substitute or 2 eggs
- ½ cup skim or low-fat milk
- 1 tablespoon prepared mustard
- 2 teaspoons prepared horseradish
- ¼ teaspoon salt
- ¼ teaspoon black pepper

Position multipurpose blade in work bowl. Add bread. Process until fine, about 5 to 10 seconds. Add ham cubes. Pulse 4 to 5 times, about 1 to 2 seconds each time, until chopped. Add onion, bell pepper, and carrot. Pulse 6 to 7 times, about 2 to 3 seconds each time, until vegetables are chopped. Add turkey, egg substitute, milk, mustard, horseradish, salt, and pepper. Pulse 6 to 7 times, about 3 to 4 seconds each time, until mixed.

Form into loaf in ungreased 8 x 4 x 2-inch loaf pan. Bake at 350°F for 1 to 1½ hours, until set and center reaches 170°F. Let stand for 5 minutes. Remove from pan.

Yield: 8 servings.

Per serving: About 189 cal, 22 g pro, 7 g car, 7 g fat, 56 mg chol, 707 mg sod.



BREADS



## CRACKED WHEAT BREAD

- 1 cup water
- 2 tablespoons margarine or butter
- 1 package active dry yeast
- 2 $\frac{1}{4}$  cups bread flour\*
- $\frac{3}{4}$  cup cracked wheat
- 2 tablespoons brown sugar
- 1 $\frac{1}{4}$  teaspoons salt

Combine water and margarine in small saucepan. Heat over low heat until warm, 105°F to 115°F. Stir in yeast to dissolve.

Position dough blade in work bowl. Add flour, cracked wheat, sugar, and salt. Process 10 to 12 seconds. With processor running, slowly add yeast mixture through feed tube until dough forms a ball, about 1 to 1 $\frac{1}{4}$  minutes. Dough will be slightly sticky.

Place dough in greased bowl, turning dough to grease all sides. Cover. Let rise in warm place until double in size, about 1 to 1 $\frac{1}{4}$  hours.

Punch dough down. Shape into a loaf and place in greased 8 $\frac{1}{2}$  x 4 $\frac{1}{2}$  x 2 $\frac{1}{2}$ -inch loaf pan. Cover. Let rise in warm place until double, about 1 $\frac{1}{4}$  to 1 $\frac{1}{2}$  hours.

Bake at 375°F for 35 to 40 minutes, until loaf is well browned and sounds hollow when tapped. Remove loaf from pan immediately. Cool on wire rack.

Yield: 1 loaf (12 1-slice servings).

\* You can substitute all-purpose flour, but the loaf may not be as large.

Per serving: About 129 cal, 3 g pro, 25 g car, 2 g fat, 0 mg chol, 246 mg sod.



## WHITE BREAD

- 3/4 cup water*
- 1/4 cup milk*
- 2 tablespoons margarine or butter*
- 1 package active dry yeast*
- 3 cups bread flour\**
- 1 tablespoon sugar*
- 1 teaspoon salt*

Combine water, milk, and margarine in small saucepan. Heat over low heat until warm, 105°F to 115°F. Stir in yeast to dissolve.

Position dough blade in work bowl. Add flour, sugar, and salt. Process 4 to 5 seconds. With processor running, slowly add yeast mixture through feed tube until dough forms a ball, about 1 to 1¼ minutes. Dough will be slightly sticky.

Place dough in greased bowl, turning dough to grease all sides. Cover. Let rise in warm place until double in size, about 1 to 1¼ hours.

Punch dough down. Shape into a loaf and place in a greased 9 x 5 x 3-inch loaf pan. Cover. Let rise in a warm place until double, about 1 to 1¼ hours.

Bake at 375°F for 35 to 40 minutes, until loaf is deep golden brown and sounds hollow when tapped. Remove loaf from pan immediately. Cool on rack.

Yield: 1 loaf (12 1-slice servings).

\* You can substitute all-purpose flour, but the loaf may not be as large.

Per serving: About 150 cal, 4 g pro, 28 g car, 2 g fat, 0 mg chol, 203 mg sod.

### **VARIATIONS:**

#### **Cinnamon Bread**

After first rising, roll out dough and spread with 1 tablespoon soft margarine. Sprinkle with 3 tablespoons sugar and 1 teaspoon cinnamon. Shape into loaf. Proceed as with white bread recipe.

Per serving: About 171 cal, 4 g pro, 28 g car, 3 g fat, 0 mg chol, 215 mg sod.

#### **Herb Bread**

Add 1 tablespoon each fresh chopped basil, thyme, and chives to flour mixture. Proceed as with white bread recipe.

Per serving: About 150 cal, 4 g pro, 28 g car, 2 g fat, 0 mg chol, 203 mg sod.



## OATMEAL RAISIN SCONES

- 1½ cups all-purpose flour*
- ¾ cup rolled oats*
- 3 teaspoons baking powder*
- ½ teaspoon cinnamon*
- ¼ teaspoon salt*
- 1 tablespoon plus 1 teaspoon sugar, divided*
- ⅓ cup raisins*
- ⅓ cup cold margarine or butter, cut in ½-inch pieces*
- ¼ cup fat-free egg substitute or 1 egg*
- ½ cup half and half*

Grease cookie sheet.

Position multipurpose blade in work bowl. Add flour, oats, baking powder, cinnamon, salt, and 1 tablespoon sugar. Process until thoroughly mixed, about 10 seconds. Add raisins. Process to coarsely chop, about 5 seconds. Add margarine. Pulse 5 times, about 2 seconds each time, until mixture is crumbly.

In small bowl, combine egg substitute and half and half. With processor running, add through feed tube. Process just until dry ingredients are moistened, about 5 to 6 seconds.

Turn onto lightly floured surface. Pat into 7-inch circle, 1-inch thick. Place on greased cookie sheet. Cut into 8 wedges. Do not separate. Sprinkle with remaining 1 teaspoon sugar.

Bake at 400°F for 18 to 20 minutes, until light golden brown and firm when tapped on top. Cut into wedges. Serve warm.

Yield: 8 scones (1 scone per serving).

Per serving: About 234 cal, 5 g pro, 31 g car, 10 g fat, 6 mg chol, 321 mg sod.



## CRANBERRY PEAR COFFEE CAKE

### **Topping**

- 1/4 cup packed brown sugar*
- 2 tablespoons all-purpose flour*
- 1/2 teaspoon cinnamon*
- 1 tablespoon margarine or butter*
- 1 firm ripe pear, peeled, cored*

### **Coffee Cake**

- 1/2 cup sour cream*
- 1/4 cup margarine or butter, softened*
- 1/2 cup sugar*
- 1/4 cup fat-free egg substitute or 1 egg*
- 1 1/4 cups all-purpose flour*
- 1 teaspoon baking powder*
- 1/2 teaspoon baking soda*
- 1/2 cup cranberries*

Grease and flour 8 or 9-inch round cake pan.

Position multipurpose blade in work bowl. Add brown sugar, flour, cinnamon, and 1 tablespoon margarine. Process to mix until crumbly, about 10 seconds. Set aside.

Exchange multipurpose blade for reversible slicing/shredding disc to slice. Add pear, cut to fit feed tube, if necessary. Process to slice. Set aside.

Exchange reversible slicing/shredding disc for multipurpose blade. Add sour cream, 1/4 cup margarine, sugar, and egg substitute. Process to mix well, about 20 seconds, scraping sides of bowl after 10 seconds, if necessary. Add flour, baking powder, and baking soda. Process just until combined, about 10 seconds. Add cranberries. Pulse 10 times, about 1 second each time, until coarsely chopped.

Spread batter in baking pan. Arrange pear slices over batter. Sprinkle topping over pears. Bake at 350°F for 40 to 45 minutes, until toothpick inserted in center comes out clean.

Yield: 8 servings.

Per serving: About 263 cal, 3 g pro, 40 g car, 10 g fat, 10 mg chol, 206 mg sod.



## POPPYSEED ROLLS

- 1/3 cup warm water (105°F to 115°F)*
- 1 package active dry yeast*
- 1/2 cup skim or low-fat milk*
- 3 tablespoons margarine or butter, melted*
- 1/4 cup fat-free egg substitute or 1 egg, slightly beaten*
- 3 cups bread flour\**
- 3 tablespoons sugar*
- 1 teaspoon salt*
- 1 cup poppyseed filling*

Dissolve yeast in warm water; set aside. In small bowl, combine milk, margarine, and egg substitute.

Position dough blade in work bowl. Add flour, sugar, and salt. Process 4 to 5 seconds. With processor running, slowly add yeast and milk mixtures through feed tube until dough forms a ball, about 40 to 45 seconds. Dough will be slightly sticky.

Place dough in greased bowl, turning dough to grease all sides. Cover. Let rise in warm place until double, about 1 to 1 1/4 hours.

Punch dough down. On lightly floured surface, flatten or roll dough to a 15 x 10-inch rectangle. Spread with poppyseed filling. Roll up tightly, beginning at 15-inch side. Pinch edge to seal. Cut dough in 15 slices, 1-inch thick. Place on greased jelly roll pan so that slices do not touch. Cover. Let rise in warm place until double, about 45 minutes.

Bake at 350°F for 25 to 30 minutes, until rolls are golden brown. Drizzle with powdered sugar frosting, if desired.

Yield: 15 rolls (1 roll per serving).

\* You can substitute all-purpose flour.

Per serving: About 194 cal, 4 g pro, 37 g car, 4 g fat, 0 mg chol, 202 mg sod.



## BISCUITS

- 2 cups all-purpose flour*
- 3 teaspoons baking powder*
- 1/2 teaspoon salt*
- 1/3 cup shortening*
- 2/3 cup skim or low-fat milk*

Position multipurpose blade in work bowl. Add flour, baking powder, and salt. Pulse 3 times, about 1 second each time, until mixed. Add shortening. Pulse 5 to 6 times, about 1 second each time, until mixture is crumbly. Add milk. Pulse 5 times, about 1 second each time, until mixture forms a ball. Do not overmix.

Place dough on floured surface. Knead gently 5 or 6 times. Pat or roll to 1/2-inch thick. Cut with floured 2 to 2 1/2-inch round cutter. Place on ungreased baking sheet. Bake at 450°F for 8 to 10 minutes, until light golden brown.

Yield: 10 to 12 biscuits (1 biscuit per serving).

Per serving: About 158 cal, 3 g pro, 20 g car, 7 g fat, 0 mg chol, 229 mg sod.





## ZUCCHINI CHOCOLATE CHIP BREAD

- 1 medium zucchini, cut in 2½-inch lengths
- ½ cup margarine or butter, slightly softened
- ¾ cup sugar
- 1 teaspoon cinnamon
- 1 teaspoon baking powder
- ½ teaspoon baking soda
- ½ teaspoon salt
- ½ cup fat-free egg substitute or 2 eggs
- ½ cup buttermilk
- 1 teaspoon vanilla
- ¾ cup miniature chocolate chips
- 2 cups all-purpose flour

Grease and flour bottom of 9 x 5 x 3-inch loaf pan.

Position 4 mm shredding disc in work bowl. Add zucchini. Process to shred. Remove to colander. Drain. Wipe out work bowl.

Exchange shredding disc for multipurpose blade. Add margarine and sugar. Process until light and fluffy, about 20 seconds, scraping sides of bowl, if necessary. Add cinnamon, baking powder, baking soda, and salt. Process until mixed, about 5 seconds. With processor running, add egg substitute through feed tube. Process 20 seconds. With processor running, add buttermilk and vanilla through feed tube. Process 5 seconds. (Mixture may look curdled.)

Stop processor. Add zucchini and chocolate chips. Pulse 3 times, about 1 second each time, until mixed. Add flour. Pulse 4 to 5 times, about 1 second each time, just until mixed. Do not overmix.

Spread evenly into prepared pan. Bake at 350°F for 50 to 60 minutes, until toothpick inserted in center comes out clean. Cool in pan 10 minutes. Remove from pan. Cool completely on wire rack before cutting.

Yield: 1 loaf (12 1-slice servings).

Per serving: About 255 cal, 4 g pro, 37 g car, 11 g fat, 0 mg chol, 276 mg sod.



## FLAVORED BUTTERS

### Honey-Orange Butter

- 1/2 cup very soft butter, margarine, or reduced-calorie margarine*
- 2 tablespoons orange juice concentrate, thawed*
- 1 tablespoon honey*
- 1/2 teaspoon cinnamon*

Position mini bowl and mini blade in work bowl. Add all ingredients. Process until thoroughly mixed, about 30 seconds. Serve on warm biscuits, muffins, toast, etc.

Yield:  $\frac{1}{2}$  cup (16  $\frac{1}{2}$ -tablespoon servings).

Per serving: About 56 cal, 0 g pro, 1 g car, 6 g fat, 16 mg chol, 38 mg sod.

### Lemon-Thyme Butter

- 1/2 cup very soft butter, margarine, or reduced-calorie margarine*
- 1 tablespoon fresh thyme leaves (stripped from stem)*
- 4 teaspoons lemon juice*

Position mini bowl and mini blade in work bowl. Add all ingredients. Process until thoroughly mixed, about 30 seconds. Serve on cooked carrots, green beans, zucchini, etc.

Yield:  $\frac{1}{2}$  cup (16  $\frac{1}{2}$ -tablespoon servings).

Per serving: About 51 cal, 0 g pro, 0 g car, 6 g fat, 16 mg chol, 39 mg sod.

### Cheesy Garlic Butter

- 1 clove garlic*
- 1/2 cup very soft butter, margarine, or reduced-calorie margarine*
- 1/4 cup freshly grated Parmesan cheese*

Position mini bowl and mini blade in work bowl. With processor running, add garlic through feed tube. Process until coarsely chopped, about 5 seconds. Add remaining ingredients. Process until well mixed, about 30 seconds. Serve on grilled vegetables or as a spread for garlic bread or toast.

Yield:  $\frac{1}{2}$  cup (16  $\frac{1}{2}$ -tablespoon servings).

Per serving: About 58 cal, 1 g pro, 0 g car, 6 g fat, 17 mg chol, 67 mg sod.

A decorative graphic featuring a fork and a knife crossed at their handles, positioned behind a large, stylized letter 'O'. The entire graphic is rendered in a light gray color. The word "DESSERTS" is written in a bold, red, serif font across the center of the 'O' and the fork and knife.

# DESSERTS



## CARROT CAKE

### **Cake**

- 1 pound carrots, cut in 2½-inch lengths
- 2 cups sugar
- ⅔ cup vegetable oil
- ¾ cup fat-free egg substitute or 3 eggs
- 2 teaspoons vanilla
- 2¼ cups all-purpose flour
- 2 teaspoons baking soda
- 2 teaspoons cinnamon
- ½ teaspoon salt
- ¼ teaspoon nutmeg
- ½ cup pecan halves or pieces

### **Frosting**

- 4 ounces no-fat pasteurized process cream cheese product, cut in 2 pieces
- 1 tablespoon margarine or butter
- 1 teaspoon vanilla
- 2½ cups powdered sugar
- 3 tablespoons pecan halves or pieces, if desired
- 3 tablespoons raisins, if desired
- 2 tablespoons shredded coconut, if desired

Spray 13 x 9 x2-inch baking pan with no-stick cooking spray. Flour pan lightly. Set aside.

Position 4 mm shredding disc in work bowl. Add carrots. Process to shred. (Yield should be about 3 cups.)

Exchange shredding disc for multipurpose blade. Add sugar, oil, egg substitute, and vanilla. Process until thoroughly mixed, about 5 to 8 seconds. Spread flour, soda, cinnamon, salt, and nuts evenly over carrot mixture in bowl. Pulse 3 to 4 times, about 2 to 3 seconds each time, until just blended.

Hold blade firmly in work bowl to prevent leakage and pour batter evenly into prepared pan. Bake at 350°F for 40 to 55 minutes, until wooden pick inserted in center comes out clean. Cool on rack.

Clean work bowl. Position multipurpose blade in work bowl. Add cream cheese product, margarine, and vanilla. Process until thoroughly mixed, about 5 to 10 seconds. Add powdered sugar. Pulse 3 to 4 times, about 2 to 3 seconds each time, until mixed.

Refrigerate frosting in work bowl until cake is cooled. If necessary, pulse 2 to 3 times, about 1 to 2 seconds each time, until frosting returns to spreading consistency. Add pecans, raisins, and coconut, if desired. Pulse 2 to 3 times, about 2 to 3 seconds each time, until mixed. Spread over cooled cake.

Yield: 12 to 16 servings.

Per serving: About 518 cal, 7 g pro, 85 g car, 18 g fat, 0 mg chol, 428 mg sod.



## CHEESECAKE

### **Crust**

- 16 *2½-inch square graham crackers, broken in half*
- 2 *tablespoons sugar*
- 3 *tablespoons, margarine or butter, melted*

### **Filling**

- 1 *cup sugar*  
*Thin yellow peel from 1 medium lemon, cut in strips*
- 2 *packages (8 oz. each) cream cheese*
- 1 *cup fat-free egg substitute or 4 eggs*
- ¼ *cup fresh lemon juice*
- 2 *tablespoons all-purpose flour*

Position multipurpose blade in work bowl. Add graham crackers and 2 tablespoons sugar. Process until fine, about 25 to 35 seconds.

With processor running, add margarine through feed tube. Process until blended, about 5 to 10 seconds. Press firmly into bottom and ¾-inch up sides of 9-inch springform pan. Chill.

Add 1 cup sugar and lemon peel to work bowl. Process until peel is finely chopped, about 20 to 25 seconds. Add cream cheese. Process until blended, about 10 to 15 seconds. Add egg substitute, lemon juice, and flour. Process until smooth, about 15 to 20 seconds.

Pour into pan. Bake at 350°F for 45 to 55 minutes, until edges are set and center is soft-set. Cool 1 to 2 hours on rack. Refrigerate at least 4 hours. Remove pan.

Yield: 10 to 12 servings.

Per serving: About 341 cal, 7 g pro, 34 g car, 20 g fat, 51 mg chol, 294 mg sod.



## FRESH FRUIT TART

### **Crust**

- 1 *pastry crust (pg.83)*
- 1 *tablespoon fat-free egg substitute plus 1 teaspoon water or 1 egg, beaten and 1 tablespoon water*

### **Filling**

- $\frac{1}{4}$  *cup sugar*
- 1 *tablespoon cornstarch*
- $\frac{3}{4}$  *cup skim or low-fat milk*
- $\frac{1}{4}$  *cup fat-free egg substitute or 1 egg, beaten*
- $\frac{1}{2}$  *teaspoon vanilla*

### **Fruit Topping**

- 1 *small mango, peeled, halved, pit removed*
- 1 *cup fresh strawberries, hulled*
- 1 *kiwi fruit, peeled*
- 2 *tablespoons strawberry or apple jelly, melted*

Prepare pastry crust as directed in recipe. Fit into 10-inch tart pan. Trim edges. Prick shell thoroughly with fork. Bake at 425°F for 9 to 12 minutes, until light golden brown. Brush shell with egg mixture to seal holes. Bake for 1 minute to set egg. Cool completely.

In small saucepan, combine sugar and cornstarch. Add milk and egg substitute. Cook and stir over medium heat until thickened. Remove from heat. Add vanilla. Refrigerate until completely cooled.

Position reversible slicing/shredding disc in work bowl. Add mango. Process to slice. Repeat with strawberries and kiwi fruit.

Spread cooled custard mixture in cooled shell. Arrange sliced fruit on custard. Brush with melted jelly. Refrigerate until serving.

Yield: 8 to 10 servings.

Per serving (filling and crust): About 332 cal, 6 g pro, 43 g car, 16 g fat, 0 mg chol, 201 mg sod.



## LIGHT CRANBERRY CREAM CHEESE BARS

- 3/4 cup dried cranberries or dried cherries*
- 3 tablespoons apple juice or water*
- 1 cup plus 1 tablespoon all-purpose flour, divided*
- 1 1/3 cups old-fashioned rolled oats*
- 3/4 cup packed brown sugar*
- 1/2 teaspoon cinnamon*
- 1/2 teaspoon baking soda*
- 2/3 cup cold margarine or butter, cut up*
- 1 package (8 oz.) no-fat pasteurized process cream cheese product, cut in 4 pieces*
- 1 cup no-fat sour cream*
- 1/2 cup fat-free egg substitute or 2 eggs*
- 2/3 cup sugar*
- 2 teaspoons vanilla*

Spray 13 x 9 x 2-inch baking pan with no-stick cooking spray.

In small saucepan over medium heat, cook cranberries and apple juice until bubbly. Cover. Reduce heat to low. Cook for 2 minutes. Set aside.

Position multipurpose blade in work bowl. Add 1 cup flour, oats, brown sugar, cinnamon, and baking soda. Process until mixed, about 5 to 10 seconds. Add margarine. Pulse 4 to 5 times, about 2 to 3 seconds each time, until crumbly. Reserve 1 cup of mixture for topping. Press remaining mixture into prepared pan. Bake at 350°F for 10 minutes.

Add cream cheese, sour cream, egg substitute, sugar, remaining 1 tablespoon flour, and vanilla to work bowl. Process until smooth, about 10 to 15 seconds, scraping sides of bowl, if necessary. Add cranberry mixture. Pulse 1 to 2 times, about 1 to 2 seconds each time, until mixed.

Spread over partially baked crust. Sprinkle with reserved crumb mixture. Bake at 350°F for 25 to 35 minutes, until center is set and top is light golden. Refrigerate until serving. Cut in bars.

Yield: 20 to 24 servings.

Per serving: About 195 cal, 6 g pro, 27 g car, 7 g fat, 5 mg chol, 295 mg sod.



## INSTANT CHOCOLATE SAUCE

- 1/3 cup packed brown sugar*
- 1/4 cup sugar*
- 1/4 cup semi-sweet chocolate chips*
- 1/3 cup skim or low-fat milk*
- 1 tablespoon margarine or butter*
- 2 tablespoons light corn syrup*
- 3/4 teaspoon vanilla*

Position multipurpose blade in work bowl. Add sugars and chocolate chips. Process until chocolate is finely chopped, about 25 to 30 seconds.

In small saucepan, heat milk, margarine, and corn syrup until very hot but not boiling. With processor running, add hot milk mixture through feed tube. Add vanilla. Process until smooth, about 5 to 10 seconds, scraping sides of bowl, if necessary. Serve warm or cool.

Yield: 1 cup (16 1-tablespoon servings).

Per serving: About 58 cal, 0 g pro, 12 g car, 2 g fat, 0 mg chol, 16 mg sod.

## ORANGE-CHOCOLATE MOUSSE

- 1/2 cup semi-sweet chocolate chips*
- 1/4 cup sugar*
- Orange portion only of peel from 1/3 medium orange, cut in strips*
- 1/2 cup skim milk*
- 1 teaspoon unflavored gelatin*
- 1 tablespoon water*
- 1 1/2 cups light whipped topping*

Position multipurpose blade in work bowl. Add chocolate chips, sugar, and orange peel. Process until chocolate and peel are finely chopped, about 30 to 40 seconds.

In small saucepan over medium heat, heat milk until very hot but not boiling.

In small bowl, sprinkle gelatin over water. Let stand for 10 to 15 seconds to soften. Add to hot milk. Reduce heat to medium-low. Cook and stir until gelatin dissolves.

With processor running, slowly add hot milk mixture through feed tube. Process until smooth, about 10 to 20 seconds, scraping sides of bowl, if necessary. Remove to medium mixing bowl.

Refrigerate for 10 to 15 minutes. Fold in whipped topping. Pour into individual dessert dishes, if desired. Chill completely.

Yield: 6 servings.

Per serving: About 146 cal, 2 g pro, 22 g car, 6 g fat, 1 mg chol, 25 mg sod.

**Variation:** Omit orange peel. Add 1/4 teaspoon almond extract with milk mixture.





## PASTRY CRUST

### **One Crust**

1 *cup all-purpose flour*

$\frac{1}{4}$  *teaspoon salt*

$\frac{1}{4}$  *cup shortening*

1 *tablespoon cold margarine or butter*

2-4 *tablespoons ice water*

### **Two Crusts**

2 *cups all-purpose flour*

$\frac{3}{4}$  *teaspoon salt*

$\frac{1}{2}$  *cup shortening*

3 *tablespoons cold margarine or butter*

5-7 *tablespoons ice water*

Position multipurpose blade in work bowl. Add flour and salt. Process until mixed, about 2 seconds. Add shortening and margarine. Pulse 3 to 4 times, about 2 to 3 seconds each time, until crumbly. Sprinkle minimum amount of water evenly over mixture. Pulse 1 to 3 times, about 2 to 3 seconds each time, until mixture pulls away from sides of bowl and forms a loose ball.

Form into a ball (2 balls for 2-crust pie). On lightly floured surface, roll each ball to a circle 2 inches larger than inverted pie plate. Fit into pie plate. Proceed as directed in pie recipe.

To bake single crust shell, flute edges of crust. Prick shell thoroughly with fork. Bake at 425°F for 9 to 12 minutes, until light golden brown.

To bake 2-crust pie, follow directions in pie recipe.

Yield: 1 pie (6 or 8 servings).

### **One Crust (6 servings for main dish pie)**

Per serving: About 168 cal, 2 g pro, 16 g car, 11 g fat, 0 mg chol, 111 mg sod.

### **One Crust (8 servings)**

Per serving: About 126 cal, 2 g pro, 12 g car, 8 g fat, 0 mg chol, 84 mg sod.

### **Two Crusts (8 servings)**

Per serving: About 265 cal, 3 g pro, 24 g car, 17 g fat, 0 mg chol, 250 mg sod.



## APPLE PIE

- 2 *pastry crusts*  
(pg. 89)
- $\frac{1}{3}$  *cup sugar*
- $\frac{1}{4}$  *cup packed brown sugar*
- 2 *tablespoons all-purpose flour*
- 1 *teaspoon cinnamon*
- $\frac{1}{8}$  *teaspoon nutmeg*
- 5 *medium to large crisp apples (Gala or Rome), peeled, cored, halved lengthwise*
- 1 *tablespoon margarine or butter, cut up*
- 2 *teaspoons milk, if desired*
- 1 *tablespoon sugar, if desired*

Prepare pastry crust as directed in recipe. Fit one crust into 9-inch pie plate. Cover both halves of crust with plastic wrap. Set aside.

Position multipurpose blade in work bowl. Add sugars, flour, cinnamon, and nutmeg. Process until mixed, about 2 to 3 seconds.

Exchange multipurpose blade for 4 mm slicing disc. Fit apples upright in feed tube, cutting into quarters if necessary. Process to slice.

Remove apples and sugar mixture to large mixing bowl. Stir gently to coat. Spoon mixture into unbaked pie shell. Dot with margarine.

Cover with top crust. Seal edge and flute. If desired, brush with milk and sprinkle with sugar. Cut 6 to 8 slits in top crust, allowing steam to escape. Bake at 425°F for 45 to 60 minutes, until crust is golden brown and filling begins to bubble. Cool on rack.

Yield: 8 servings.

Per serving (filling and crust): About 661 cal, 7 g pro, 78 g car, 36 g fat, 0 mg chol, 521 mg sod.



## THUMBPRINT COOKIES

- 1/2 cup sugar*
- 2/3 cup margarine or butter, cut up*
- 1/4 cup fat-free egg substitute or 1 egg*
- 1 teaspoon vanilla*
- 1 1/2 cups all-purpose flour*
- 1/2 teaspoon baking powder*
- 1/4 cup pecan or walnut halves or pieces, if desired*
- 2-3 tablespoons any flavor jelly*

Position multipurpose blade in work bowl. Add sugar and margarine. Process until blended, about 10 to 15 seconds. Add egg substitute and vanilla. Process until blended, about 30 seconds. Spread flour, baking powder, and nuts evenly over mixture. Pulse 2 to 3 times, about 2 to 3 seconds each time, just until mixed.

Roll into 1-inch balls. (Lightly flour hands if dough is sticky.) Place balls 2 inches apart on ungreased baking sheet. Make a deep indentation in each cookie with thumb.

Bake at 350°F for 9 to 13 minutes, until bottoms of cookies are light golden and edges begin to turn light golden. Remove to cooling rack. Fill each cookie center with about 1/4 teaspoon jelly. Cool completely.

Yield: 2 dozen cookies (1 cookie per serving).

Per serving: About 104 cal, 1 g pro, 12 g car, 6 g fat, 0 mg chol, 73 mg sod.



## COOKIE CRUMB CRUST

### **Graham Crust**

20 *2½-inch square  
graham crackers*  
3 *tablespoons sugar*  
*⅓ cup margarine or  
butter, melted*

Position multipurpose blade in work bowl. Add crackers or cookies and sugar. Process until fine, about 35 to 50 seconds. With processor running, add melted margarine through feed tube. Process until blended, about 10 to 20 seconds.

Press crumbs firmly into 9-inch pie plate to line bottom and sides. Bake at 350°F for 7 to 9 minutes, until set. Cool completely. Fill.

Yield: 1 pie crust (8 servings).

Per serving: About 159 cal, 1 g pro, 18 g car, 9 g fat, 1 mg chol, 200 mg sod.

### **VARIATIONS:**

#### **Chocolate Wafer Crust**

Use 20 *2⅜-inch chocolate wafers*, 3 tablespoons sugar, and *¼ cup margarine, melted*.

Per serving: About 117 cal, 0 g pro, 12 g car, 8 g fat, 0 mg chol, 116 mg sod.

#### **Vanilla Wafer Crust**

Use 25 *1⅜-inch vanilla wafers*, 2 tablespoons sugar, and *¼ cup margarine, melted*.

Per serving: About 162 cal, 1 g pro, 16 g car, 10 g fat, 8 mg chol, 125 mg sod.

#### **Ginger Snap Crust**

Use 24 *2-inch ginger snaps* and *¼ cup margarine, melted*.

Per serving: About 162 cal, 1 g pro, 19 g car, 9 g fat, 0 mg chol, 210 mg sod.



## Optional Attachments and Accessories

---

- **Reversible Thin (2mm) Slicing/Shredding Disc - Model KFPRD2**
- **Medium (4mm) Slicing Disc - Model KFPSL4**
- **Thick (6mm) Slicing Disc - Model KFPSL6**
- **Medium (4mm) Shredding Disc - Model KFPSH4**
- **Thick (6mm) Shredding Disc - Model KFPSH6**
- **French Fry Disc - Model KFPPF**
- **Parmesan/Ice Grating Disc - Model KFPPS**
- **Julienne Disc - Model KFPJU**
- **Egg Whip - Model KFP6EW**
- **Citrus Juicer - Model KFPCJ**  
Use to make fresh citrus juice with grapefruits, oranges, lemons, and limes.
- **Juice Extractor - Model KFPJE**  
Use to extract juice from carrots, celery, tomatoes, and other vegetables.
- **6 Disc Storage Rack - Model KFPDS6**  
Stores 6 discs conveniently.
- **Storage Box - Model KFPSB**  
Stores multipurpose blade, dough blade, three slicing or shredding discs, disc stem, and egg whip in a clear, covered box.



# NOTES

---



# NOTES

---

**KitchenAid®**

KITCHENAID is a registered Trademark of KitchenAid, U.S.A.